

Handles & Knobs Index by Item No.

Item No.	Page	Description	Item No.	Page	Description
H001	42	Tapered Bow Handle	H688	34	Flat Feet Handle
H004	26	Pyramid Handle	H801	39	Slim Bow Handle
H019	8	Knurled T-bar Handle	H815	47	Pipe Handle
H023	31	Tapered Flat Handle	H822	21	Hurdle Handle
H041	9	Standard T-bar Handle	H852	33	Oval Bar Handle
H042	41	Standard Bow Handle	H901	41	Flat-Arc Handle
H044	27	Standard D Handle	H904	29	Slim Profile Handle
H045	43	Square Arc Handle	H906	21	Radius Top Handle
H047	20	Bollard Handle	H926	22	Luxe Twist Handle
H048	42	Flat Top Bow Handle	H927	22	Luxe Bow Handle
H064	9	Flat Curved T-Bar Handle	H978	27	Flair D Handle
H068	43	Bill Handle	Handle Boards	71	
H070	18	Miele Handle	Handle Screws	70	
H101	18	Bevelled Edge Handle	Handle Drilling Jig	70	
H105	37	Flair Moustache Handle	K047	20	Bollard Knob
H108	28	Bridge Handle	K25	64	Button Ring Knob
H133	40	Mercury Handle	K38	45	Royale Knob
H145	50	Antique Bird Nest D Handle	K39	8	Knurled Flat Round Knob
H148	51	Antique Bird Nest Swivel Handle	K46	46	Antique Ceramic T Knob
H158	39	Tapered Mercury Handle	K56	65	Football Knob
H161	44	Echidna Handle	K59	51	Antique Bird Nest Knob
H201	19	Round Corner D Handle	K63	64	Mushroom Knob
H203	12	Mitred Pyramid Handle	K84	47	Antique Ceramic Knob
H208	19	Ergo Handle	K86	67	Cylinder Notched Knob
H213	46	Antique Ceramic D Handle	K91	65	Half Moon Knob
H225	56	Georgian Handle	K179	56	Antique Classic Ring Knob
H254	12	Slim Arrow Handle	K264	66	Square Pyramid Knob
H258	37	Moustache Handle	K368	36	Table Knob
H260	38	Wishbone Handle	K417	67	Rectangle Knob
H263	38	Gondola Handle	K420	66	Rectangle Pyramid Knob
H265	29	Strip Line Handle	K468	14	Round Flat Knob
H266	54	Case Handle	K508	49	Pipe Knob
H267	11	Half Round D Handle 20mm	K914	6	Solid Walnut Round Knob
H268	44	Bow Tie Handle	P15	59	L-Block Finger Pull
H269	40	Surfboard Handle	P17	57-58	L-Shaped Finger Pull
H288	14	Slim Round Corner Handle	P18	59	Lip Pull
H299	10	Half-Round D Handle 11mm	P22	58	Curled Lip Pull
H301	33	Square Post Bar Handle	P040	63	Bracket for P041/2 Shadow Line
H322	25	Plank Square Handle	P041	62	L-Shaped Shadow Line
H333	32	Harper Handle	P042	62	U-Shaped Shadow Line
H359	45	Royale Handle	P044	63	P Section Finger Pull
H364	28	Rebate Round Corner D Handle	P94s	68	Square Recess Finger Pull
H367	36	Table Handle	P148	69	Rectangle Recess Finger Pull
H401	26	Saddle-Back Cylinder Handle	P196s	68	Round Recess Finger Pull
H461	23	Slim Tapered Profile Handle	P265	54	Hampton Cup Pull
H462	23	Slim Tapered Profile Handle	P300	50	Flat Ring Pull 64mm
H463	17	Round Corner Flat D Handle	P365	69	Recess Finger Pull
H464	11	Half Round D Handle 14mm	P419	60	Square Finger Pull
H501	15-16	All Square Block Handle	P427	53	Crescent Finger Pull
H502	15	8 x 8mm Square Handle	P471	53	Shell-like Finger Pull
H503	25	Flat Square Block Handle	P480	60	Flat T Handle
H504	17	Round-Corner Square Handle	P511	2	Half Moon Lip Pull, Standard
H508	49	Pipe Handle with Sleeve	P522	2	Half Moon Lip Pull, Large
H570	32	Round Corner Slim Profile Handle	P918	4	Solid Walnut Half Moon Pull
H601	31	Flat Cylinder Handle	P950	6	Solid Walnut Round Corner T Pull
H625	34	Contour Handle	P957	4	Solid Walnut Lip Pull

Handles & Knobs Index by Finish

Item No. Page Description

Black / Matt Black



H019.....8.....	Knurled T-bar Handle
H041.....9.....	Standard T-bar Handle
H047.....20.....	Bollard Handle
H145.....50.....	Antique Bird Nest D Handle
H148.....51.....	Antique Bird Nest Swivel Handle
H225.....56.....	Georgian Handle
H265.....29.....	Strip Line Handle
H268.....44.....	Bow Tie Handle
H288.....14.....	Round Flat Knob
H299.....10.....	Half-Round D Handle 11mm
H359.....45.....	Royale Handle
H367.....36.....	Table Handle
H461.....23.....	Slim Tapered Profile Handle
H462.....23.....	Slim Tapered Profile Handle
H501.....16.....	All Square Block Handle
H508.....49.....	Pipe Handle with Sleeve
H570.....32.....	Round Corner Slim Profile Handle
H625.....34.....	Contour Handle000
H815.....47.....	Pipe Handle
H904.....29.....	Slim Profile Handle
H926.....22.....	Luxe Twist Handle
H927.....22.....	Luxe Bow Handle
K38.....45.....	Royale Knob
K39.....8.....	Knurled Flat Round Knob
K59.....51.....	Antique Bird Nest Knob
K63.....64.....	Mushroom Knob
K047.....20.....	Bollard Knob
K179.....56.....	Antique Classic Ring Knob
K368.....36.....	Table Knob
K468.....14.....	Round Flat Knob
K508.....49.....	Pipe Knob
P17.....57.....	L-Shaped Finger Pull
P22.....58.....	Curled Lip Pull
P265.....54.....	Hampton Cup Pull
P266.....54.....	Case Handle
P365.....69.....	Recess Finger Pull
P427.....53.....	Crescent Finger Pull
P471.....53.....	Shell-like Finger Pull
P480.....60.....	Flat T Handle
P511.....2.....	Half Moon Lip Pull, Standard
P522.....2.....	Half Moon Lip Pull, Large

Gunmetal



H508.....49.....	Pipe Handle with Sleeve
H815.....47.....	Pipe Handle
K508.....49.....	Pipe Knob

White



H213.....46.....	Antique Ceramic D Handle
H265.....29.....	Strip Line Handle
H268.....44.....	Bow Tie Handle
H367.....36.....	Table Handle
K46.....46.....	Antique Ceramic T Knob
K84.....47.....	Antique Ceramic Knob
K368.....36.....	Table Knob
P17.....58.....	L-Shaped Finger Pull

Walnut Wood



K914.....6.....	Solid Walnut Round Knob
P918.....4.....	Solid Walnut Half Moon Pull
P950.....6.....	Solid Walnut Round Corner T Pull
P957.....4.....	Solid Walnut Lip Pull

Item No. Page Description

Matt Chrome



H042.....41.....	Standard Bow Handle
H044.....27.....	Standard D Handle
H161.....44.....	Echidna Handle
H299.....10.....	Half-Round D Handle 11mm
H461.....23.....	Slim Tapered Profile Handle
K86.....67.....	Cylinder Notched Knob
P18.....59.....	Lip Pull
P041.....62.....	L-Shaped Shadow Line
P042.....62.....	U-Shaped Shadow Line
P044.....63.....	P Section Finger Pull
P365.....69.....	Recess Finger Pull

Chrome



H001.....42.....	Tapered Bow Handle
H041.....9.....	Standard T-bar Handle
H042.....41.....	Standard Bow Handle
H133.....40.....	Mercury Handle
H265.....29.....	Strip Line Handle
H299.....10.....	Half-Round D Handle 11mm
H501.....16.....	All Square Block Handle
H978.....27.....	Flair D Handle
K63.....64.....	Mushroom Knob
K86.....67.....	Cylinder Notched Knob
P17.....57.....	L-Shaped Finger Pull
P18.....59.....	Lip Pull
P427.....53.....	Crescent Finger Pull

Gold Finish



H019.....8.....	Knurled T-bar Handle
H288.....14.....	Round Flat Knob
H299.....10.....	Half-Round D Handle 11mm
H367.....36.....	Table Handle
H815.....47.....	Pipe Handle
H904.....29.....	Slim Profile Handle
K39.....8.....	Knurled Flat Round Knob
K63.....64.....	Mushroom Knob
K368.....36.....	Table Knob
K468.....14.....	Round Flat Knob
P511.....2.....	Half Moon Lip Pull, Standard
P522.....2.....	Half Moon Lip Pull, Large

Brass Finish



P22.....58.....	Curled Lip Pull
-----------------	-----------------

Pewter



H145.....50.....	Antique Bird Nest D Handle
H148.....51.....	Antique Bird Nest Swivel Handle
H213.....46.....	Antique Ceramic D Handle
H359.....45.....	Royale Handle
P427.....53.....	Crescent Finger Pull
P471.....53.....	Shell-like Finger Pull
K179.....56.....	Antique Classic Ring Knob
K38.....45.....	Royale Knob
K46.....46.....	Antique Ceramic T Knob
K59.....51.....	Antique Bird Nest Knob
K84.....47.....	Antique Ceramic Knob

Satin Nickel



Most of our handles come with Satin Nickel finish



Sign Up

to check prices & order online



P511 Half Moon Lip Pull, Standard

Material: Zn-Alloy

Item No.	Finish	C-C	Ø
P511-SN	Satin Nickel	64	77
P511-MB	Matt Black	64	77
P511-G	Brushed Gold	64	77



*M4 Screws Included



P522 Half Moon Lip Pull, Large

Material: Zn-Alloy

Item No.	Finish	C-C	Ø
P522-SN	Satin Nickel	96	120
P522-MB	Matt Black	96	120
P522-G	Brushed Gold	96	120



*M4 Screws Included

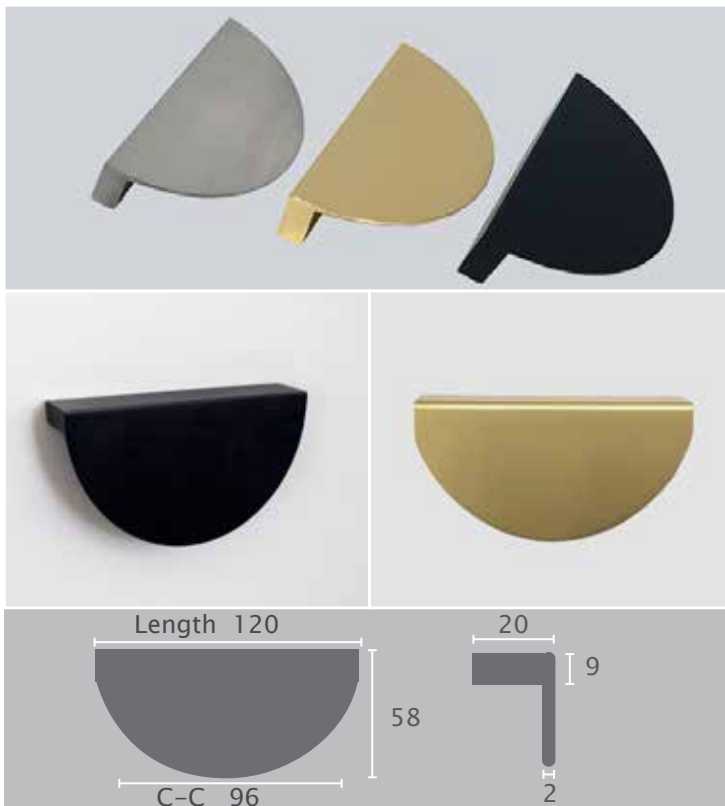
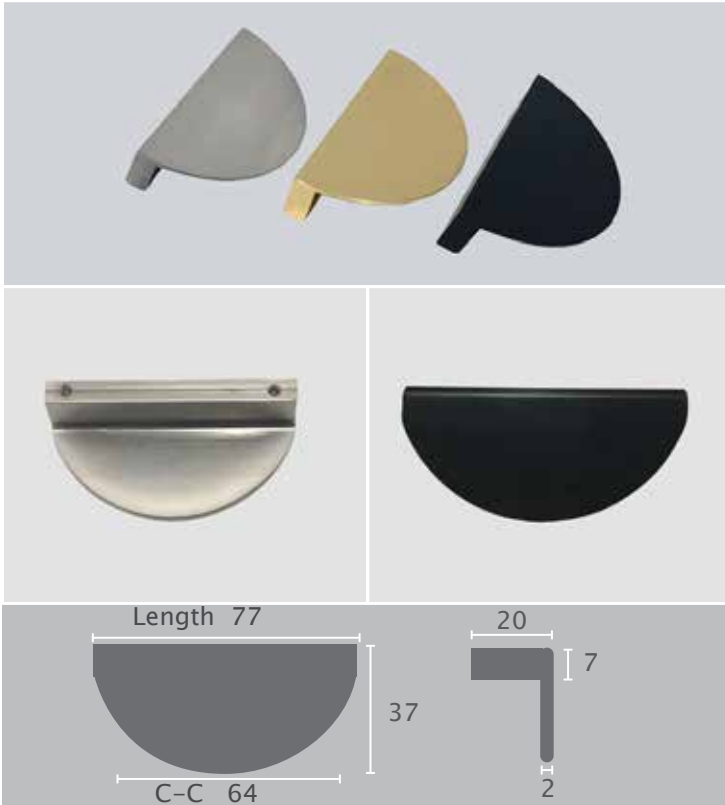

Sign Up to check prices & order online



Sign Up

to check prices & order online

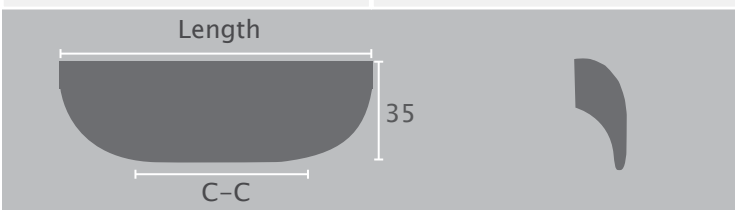

P957 Solid Walnut Lip Pull

Material: Walnut Wood

Item No.	C-C	Length
P957-64-Walnut	64	113
P957-160-Walnut	160	208

Finish



Walnut

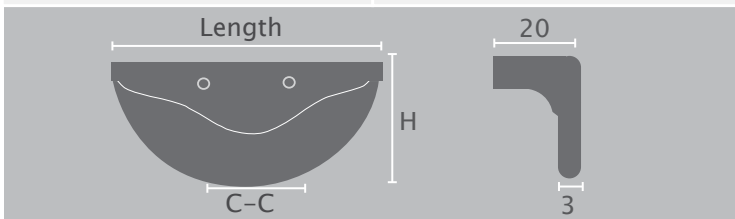

P918 Solid Walnut Half Moon Pull

Material: Walnut Wood

Item No.	C-C	Length	Height
P918-32-Walnut	32	100	50
P918-64-Walnut	64	150	75

Finish



Walnut

Sign Up

to check prices & order online



Sign Up

to check prices & order online

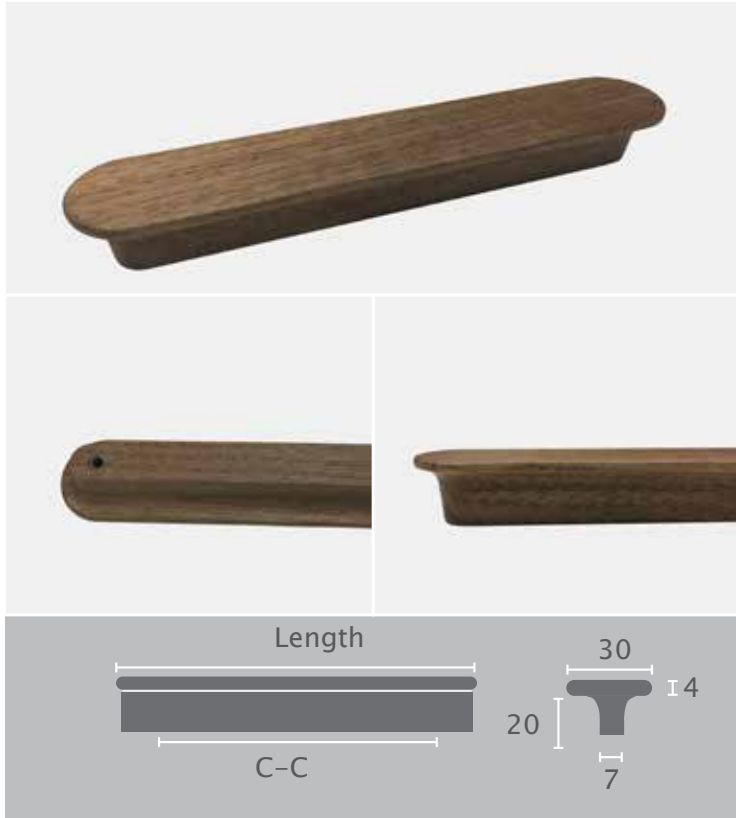

P950 Solid Walnut Round Corner T Pull

Material: Walnut Wood

Item No.	C-C	Length
P950-128-Walnut	128	162
Finish	 Walnut	



K914 Solid Walnut Round Knob

Material: Walnut Wood

Item No.	H	Ø
K914-Walnut	23	48
Finish	 Walnut	

Sign Up to check prices & order online



Sign Up

to check prices & order online

www.eurofit.com.au

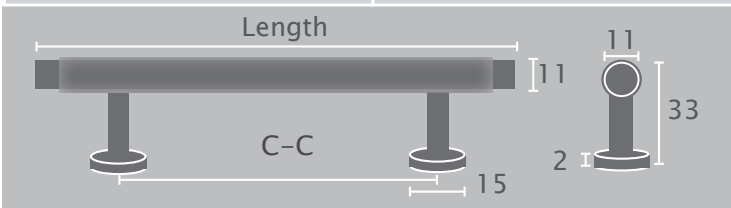

H019 Knurled T-bar Handle

Material: Zn-Alloy + Steel

Item No.	Finish	C-C	L
H019-128	Satin Nickel	128	178
H019-192	Satin Nickel	192	242
H019-320	Satin Nickel	320	370
H019-128MB	Matt Black	128	178
H019-192MB	Matt Black	192	242
H019-320MB	Matt Black	320	370
H019-128G	Brushed Gold	128	178
H019-192G	Brushed Gold	192	242
H019-320G	Brushed Gold	320	370



*M4 Screws Included

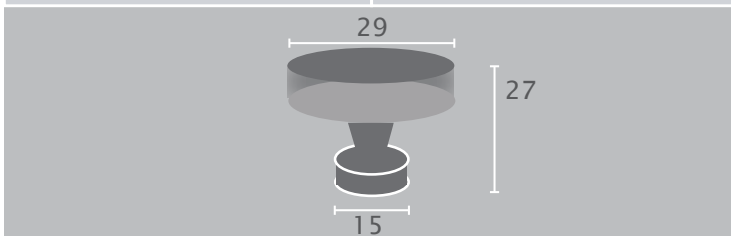

K39 Knurled Flat Round Knob

Material: Steel

Item No.	Finish	H	Ø
K39	Satin Nickel	27	30
K39-MB	Matt Black	27	30
K39-G	Brushed Gold	27	30



*M4 Screws Included

Sign Up

to check prices & order online

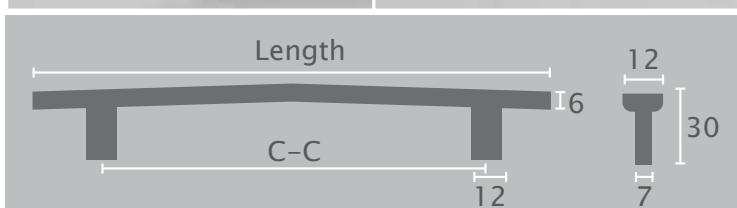
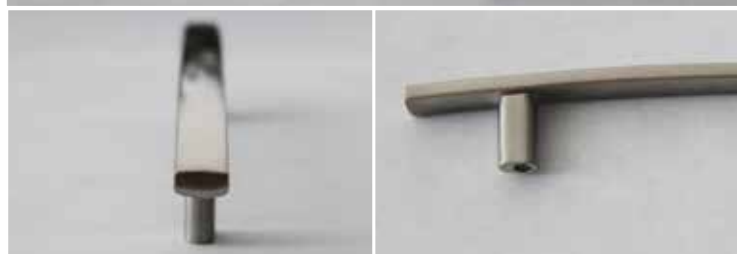

H064 Flat Curved T-Bar Handle

Material: Zn-Alloy

Item No.	C-C	Length
H064-128	128	196
H064-192	192	256

Finish



Satin Nickel

*M4 Screws Included



Polished Chrome

Satin Nickel



Matt Black

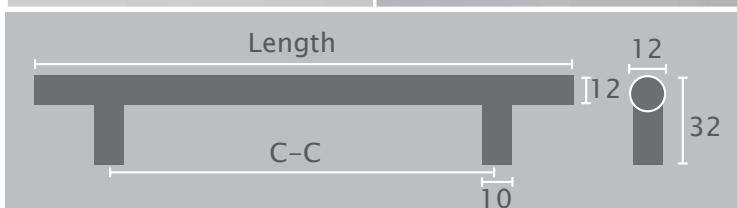

H041 Standard T-bar Handle

Material: Solid Steel

Item No.	Finish	C-C	Length
H041 - 96	Satin Nickel	96	150
H041-128	Satin Nickel	128	178
H041-160	Satin Nickel	160	210
H041-224	Satin Nickel	224	274
H041-320	Satin Nickel	320	370
H041-416	Satin Nickel	416	466
H041-608	Satin Nickel	608	658
H041-700	Satin Nickel	700	750
H041 - 96C	Polished Chrome	96	150
H041-128C	Polished Chrome	128	178
H041-160C	Polished Chrome	160	210
H041-224C	Polished Chrome	224	274
H041 - 96MB	Matt Black	96	150
H041-128MB	Matt Black	128	178
H041-160MB	Matt Black	160	220
H041-224MB	Matt Black	224	270
H041-320MB	Matt Black	320	370
H041-416MB	Matt Black	416	466

Finish



Satin Nickel



Polished Chrome



Matt Black

*M4 Screws Included

Sign Up

to check prices & order online

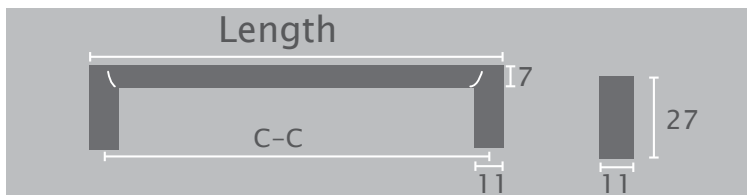
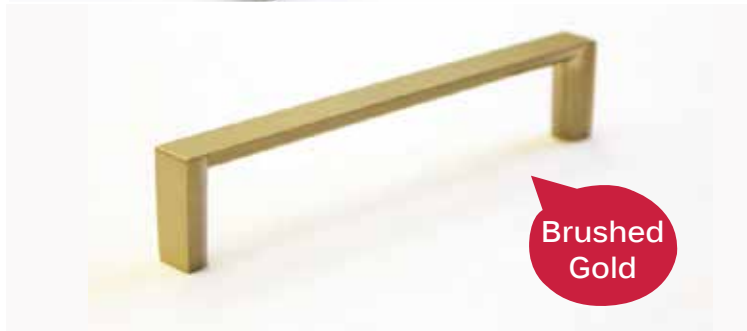
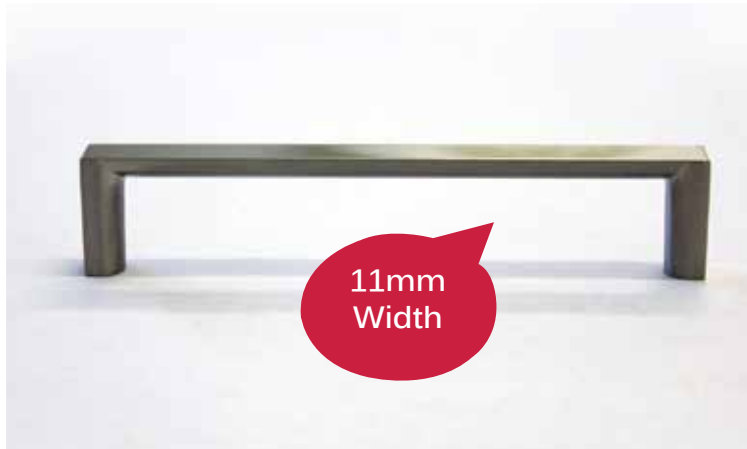

H299 Half-Round D Handle 11mm

Material: Zn-Alloy

Item No.	Finish	C-C	Length
H299 - 96	Satin Nickel	96	104
H299-128	Satin Nickel	128	136
H299-160	Satin Nickel	160	168
H299-192	Satin Nickel	192	200
H299-224	Satin Nickel	224	232
H299-256	Satin Nickel	256	264
H299-288	Satin Nickel	288	296
H299-320	Satin Nickel	320	328
H299-352	Satin Nickel	352	360
H299-416	Satin Nickel	416	424
H299 - 96C	Polished Chrome	96	104
H299-128C	Polished Chrome	128	136
H299-160C	Polished Chrome	160	168
H299-192C	Polished Chrome	192	200
H299-224C	Polished Chrome	224	232
H299-320C	Polished Chrome	320	328
H299-416C	Polished Chrome	416	424
H299 - 96MC	Matt Chrome	96	104
H299-128MC	Matt Chrome	128	136
H299-160MC	Matt Chrome	160	168
H299-224MC	Matt Chrome	224	232
H299-320MC	Matt Chrome	320	328
H299-416MC	Matt Chrome	416	424
H299 - 96MB	Matt Black	96	104
H299-128MB	Matt Black	128	136
H299-160MB	Matt Black	160	168
H299-224MB	Matt Black	224	232
H299-320MB	Matt Black	320	328
H299-416MB	Matt Black	416	424
H299-160G	Brushed Gold	160	168
H299-224G	Brushed Gold	224	232
H299-320G	Brushed Gold	320	328



*M4 Screws Included

Sign Up to check prices & order online

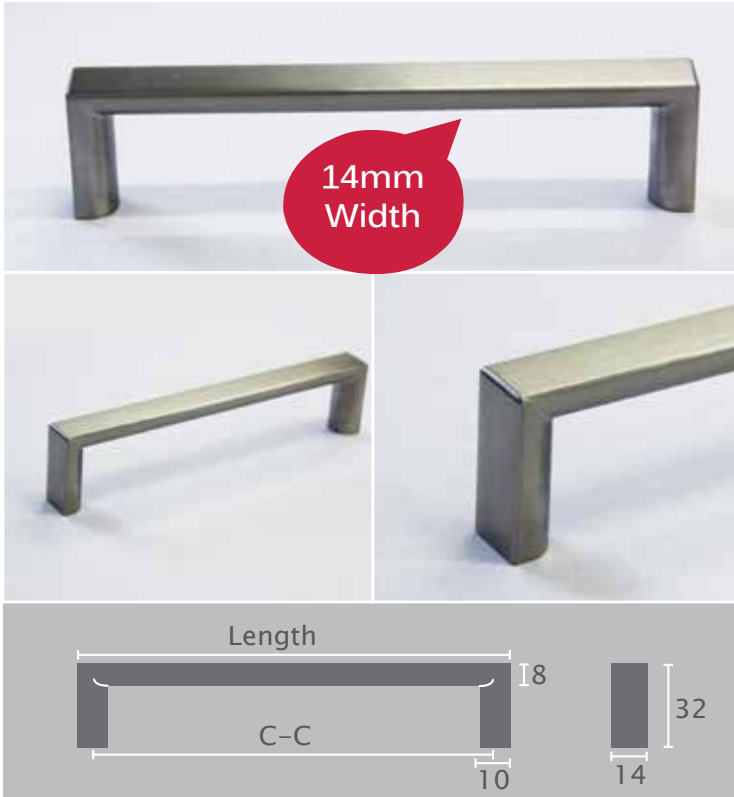

H464 Half Round D Handle 14mm

Material: Zn-Alloy

Item No.	C-C	Length
H464-128	128	140
H464-160	160	172
H464-224	224	236
H464-320	320	332
H464-416	416	428

Finish



Satin Nickel

*M4 Screws Included

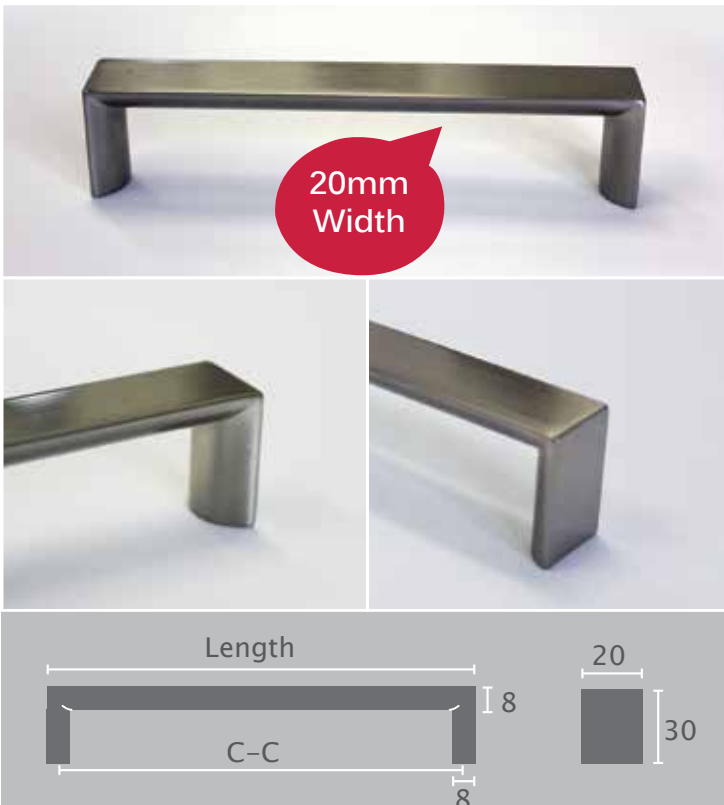

H267 Half Round D Handle 20mm

Material: Zn-Alloy

Item No.	C-C	Length
H267-128	128	136
H267-160	160	168
H267-224	224	232

Finish



Satin Nickel

*M4 Screws Included

Sign Up to check prices & order online

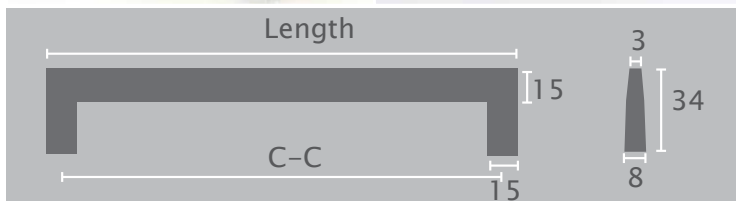
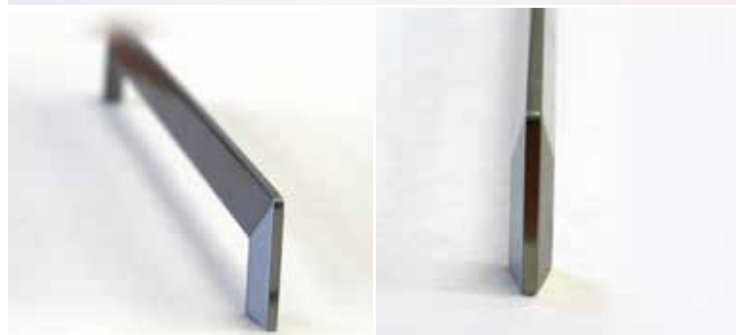

H203 Mitred Pyramid Handle

Material: Zn-Alloy

Item No.	C-C	Length
H203-128	128	150
H203-160	160	182
H203-224	224	246
H203-320	320	342
H203-416	416	438

Finish



Satin Nickel

*M4 Screws Included

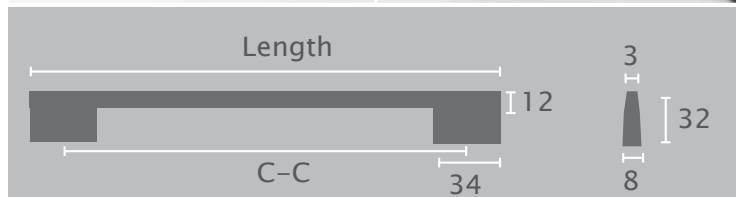

H254 Slim Arrow Handle

Material: Zn-Alloy

Item No.	C-C	Length
H254-128	128	184
H254-160	160	216
H254-224	224	280
H254-320	320	376
H254-416	416	472

Finish



Satin Nickel

*M4 Screws Included

Sign Up

to check prices & order online



Sign Up

to check prices & order online

www.eurofit.com.au

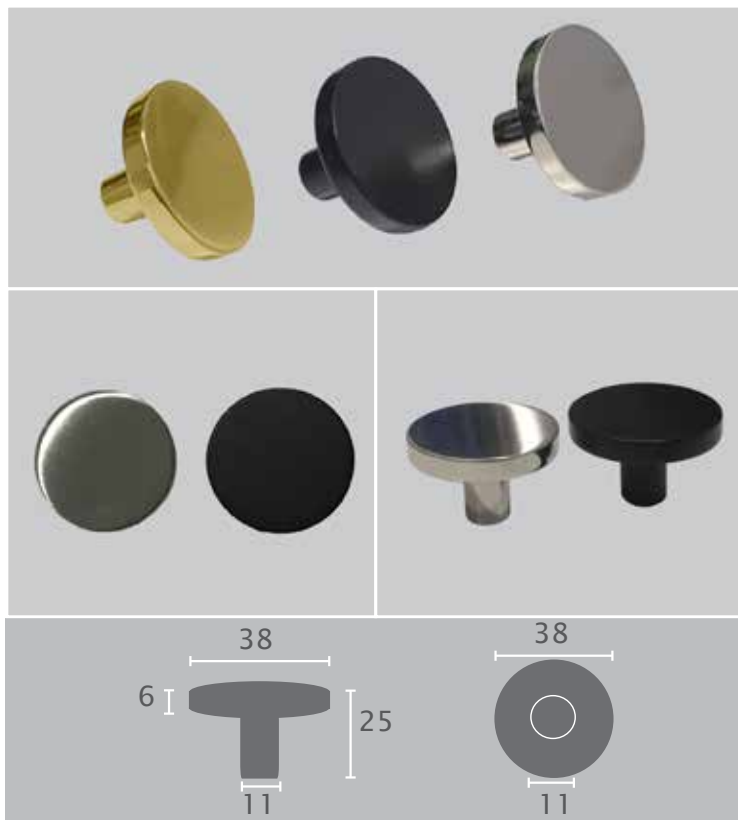

K468 Round Flat Knob

Material: Zn-Alloy

Item No.	Finish	H	Ø
K468	Satin Nickel	25	38
K468-MB	Matt Black	25	38
K468-G	Brushed Gold	25	38

Finish

*M4 Screws Included

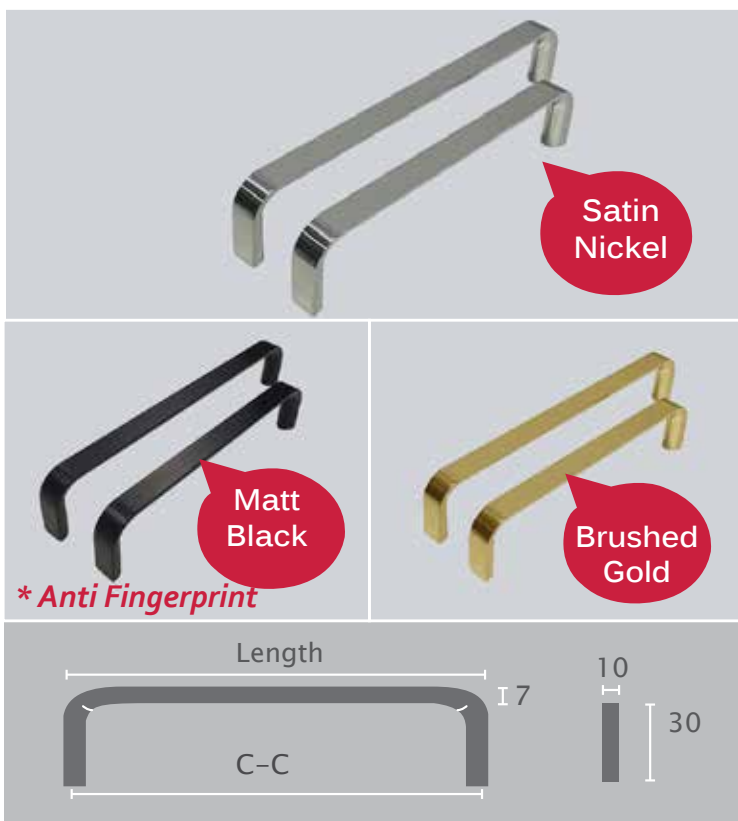

H288 Slim Round Corner Handle

Material: Zn-Alloy

Item No.	Finish	C-C	L
H288-128	Satin Nickel	128	135
H288-160	Satin Nickel	160	167
H288-224	Satin Nickel	224	231
H288-128MB	Matt Black	128	135
H288-160MB	Matt Black	160	167
H288-224MB	Matt Black	224	231
H288-128G	Brushed Gold	128	135
H288-160G	Brushed Gold	160	167
H288-224G	Brushed Gold	224	231

Finish

*M4 Screws Included

Sign Up

to check prices & order online

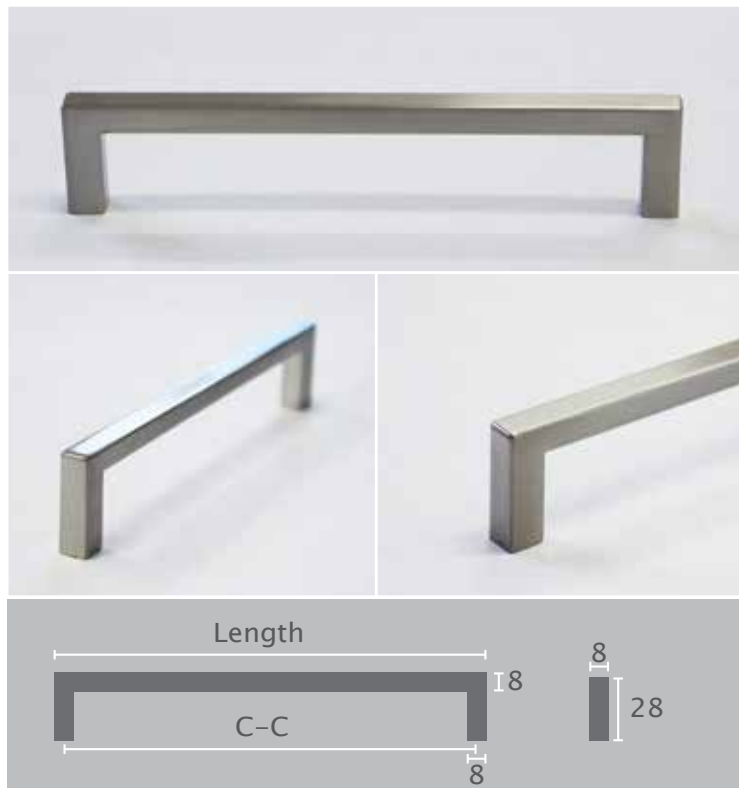

H502 8 x 8mm Square Handle

Material: Zn-Alloy

Item No.	C-C	Length
H502-128	128	136
H502-160	160	168
H502-192	192	200
H502-224	224	232
H502-320	320	328

Finish



Satin
Nickel

*M4 Screws Included

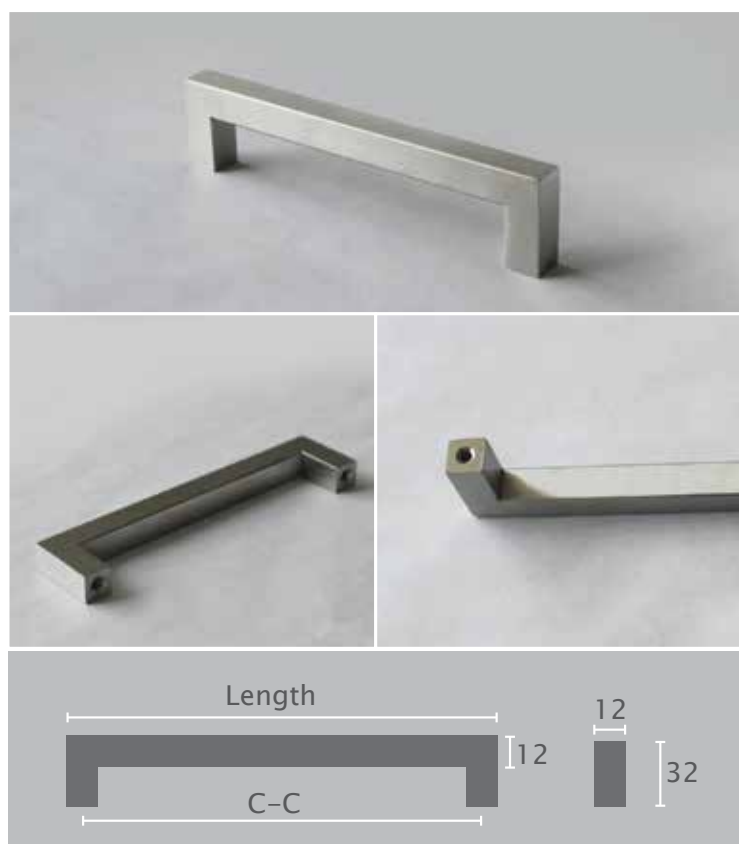

H501 All Square Block Handle

Material: 304 Stainless Steel

Item No.	C-C	Length
H501 - 96	96	108
H501-128	128	140
H501-160	160	172
H501-192	192	204
H501-224	224	236
H501-288	288	300
H501-320	320	332
H501-416	416	428
H501-608	608	620

Finish



Satin
Nickel

*M4 Screws Included

Sign Up

to check prices & order online

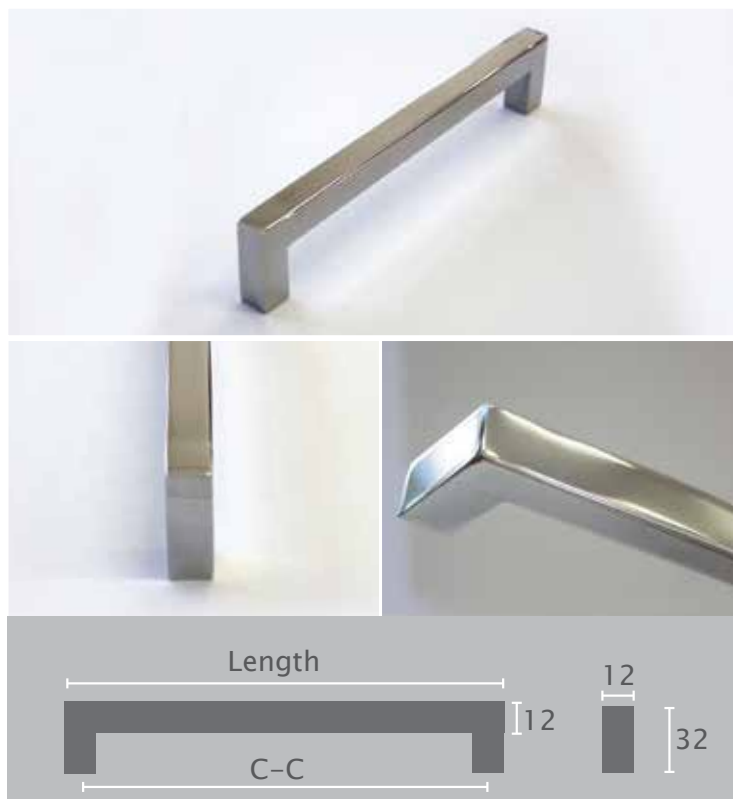

H501C All Square Block Handle

Material: 304 Stainless Steel

Item No.	C-C	Length
H501-128C	128	140
H501-160C	160	172
H501-192C	192	204
H501-224C	224	236
H501-288C	288	300
H501-320C	320	332
H501-416C	416	428

Finish



Polished
Chrome

*M4 Screws Included

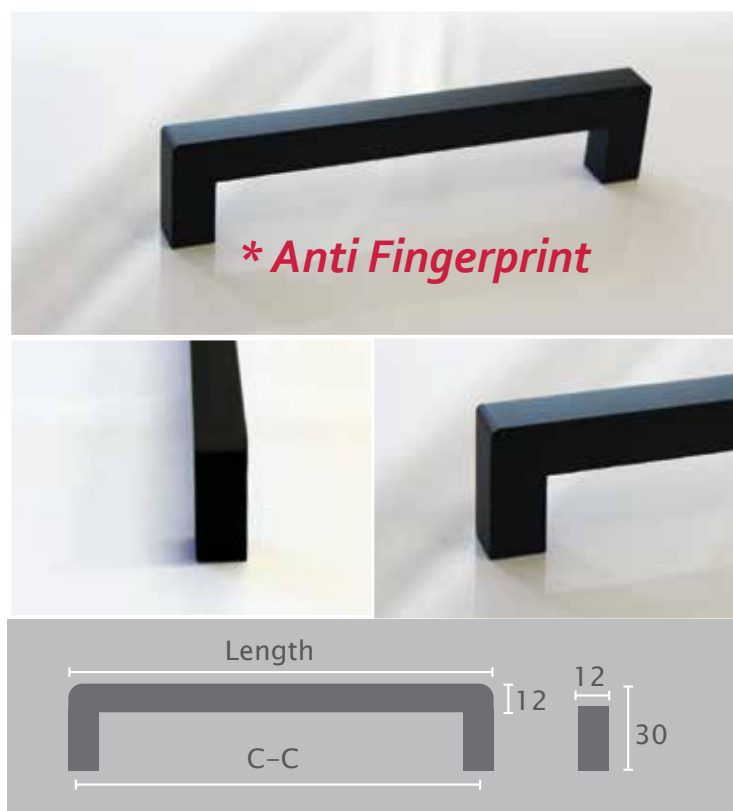

H501MB All Square Block Handle

Material: Aluminium

Item No.	C-C	Length
H501-128MB	128	140
H501-160MB	160	172
H501-224MB	224	236
H501-320MB	320	332
H501-416MB	416	428

Finish



Matt
Black

*M4 Screws Included

Sign Up

to check prices & order online

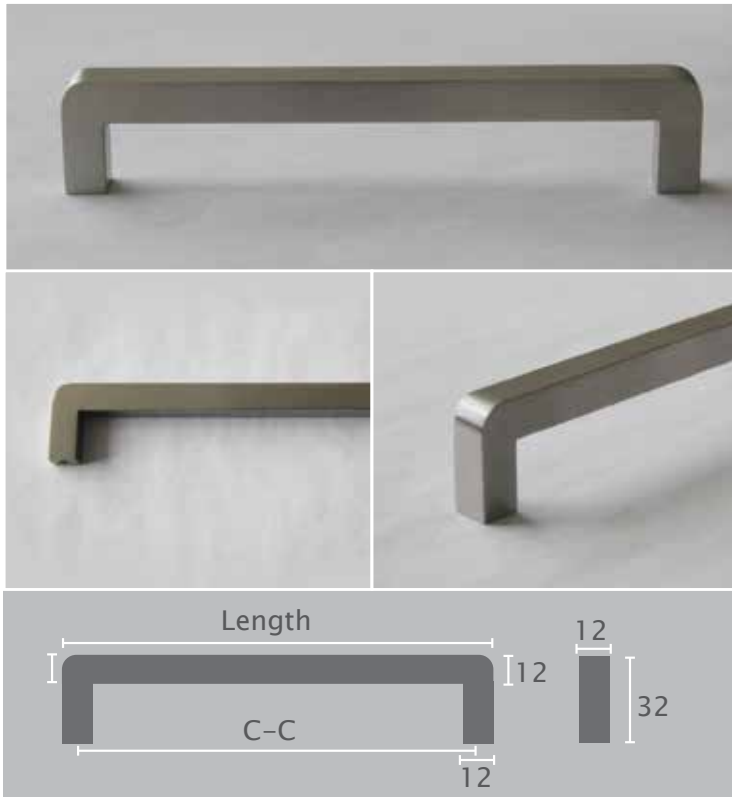

H504 Round-Corner Square Handle

Material: 304 Stainless Steel

Item No.	C-C	Length
H504 - 96	96	108
H504-128	128	140
H504-160	160	172
H504-224	224	236
H504-320	320	332
H504-416	416	428
H504-608	608	620

Finish



Satin
Nickel

*M4 Screws Included

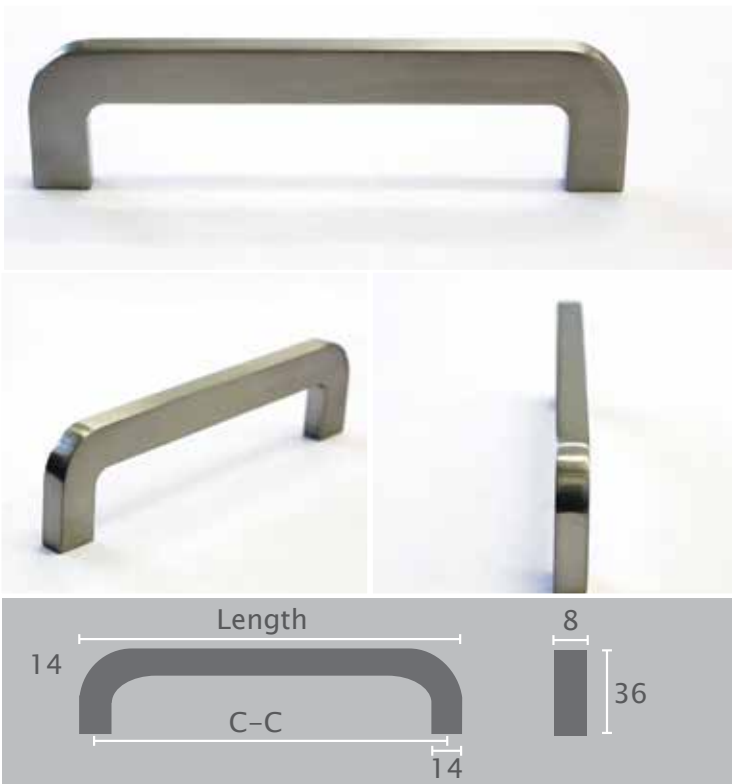

H463 Round Corner Flat D Handle

Material: Zn-Alloy

Item No.	C-C	Length
H463-128	128	142
H463-160	160	174
H463-224	224	238
H463-320	320	334
H463-416	416	430

Finish



Satin
Nickel

*M4 Screws Included

Sign Up

to check prices & order online

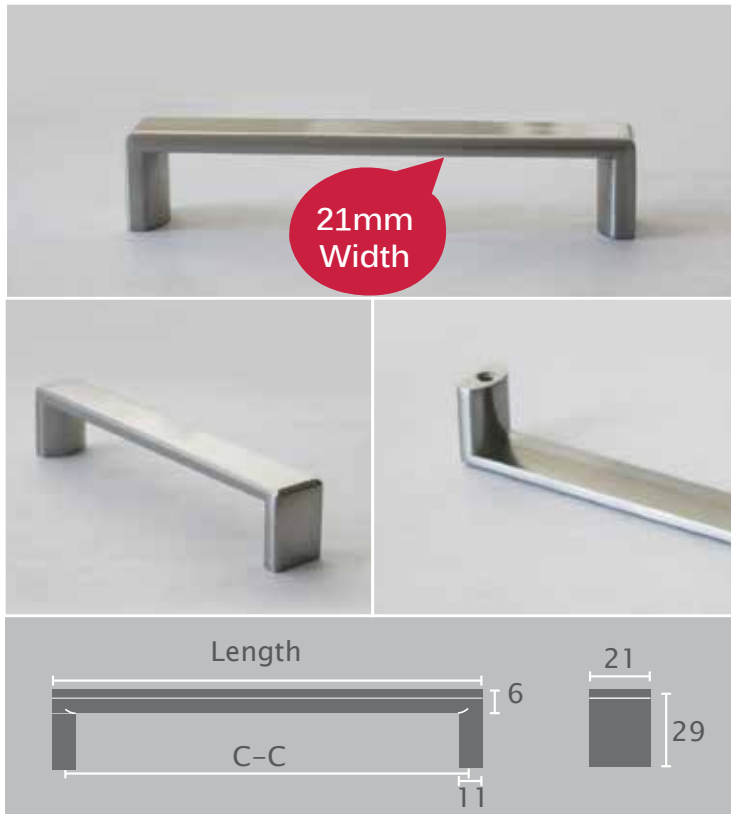

H101 Bevelled Edge Handle

Material: Zn-Alloy

Item No.	C-C	Length
H101-128	128	137
H101-160	160	169
H101-224	224	233
H101-416	416	425

Finish



Satin Nickel

*M4 Screws Included

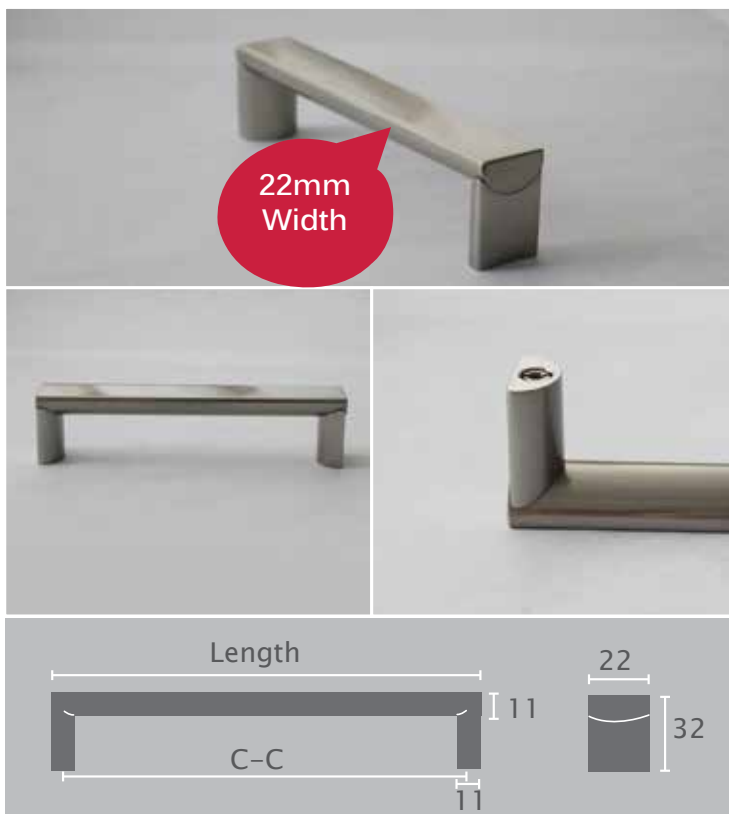

H070 Miele Handle

Material: Aluminium

Item No.	C-C	Length
H070-128	128	139
H070-160	160	171
H070-224	224	235
H070-320	320	331
H070-416	416	427
H070-608	608	619

Finish



Satin Nickel

*M4 Screws Included

Sign Up to check prices & order online

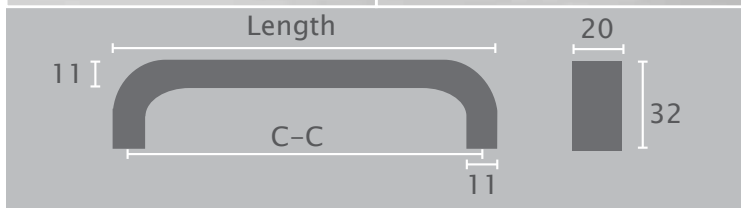

H201 Round-Corner D Handle

Material: Zn-Alloy

Item No.	C-C	Length
H201-128	128	134
H201-160	160	166
H201-224	224	230
H201-320	320	326
H201-416	416	427

Finish



Satin Nickel

*M4 Screws Included

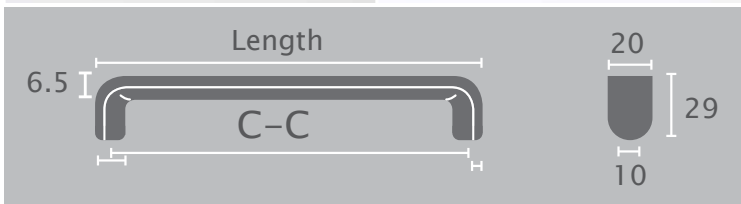

H208 Ergo Handle

Material: Zn-Alloy

Item No.	C-C	Length
H208-128	128	135
H208-160	160	167
H208-224	224	231
H208-320	320	327
H208-416	416	423

Finish



Satin Nickel

*M4 Screws Included

Sign Up

to check prices & order online

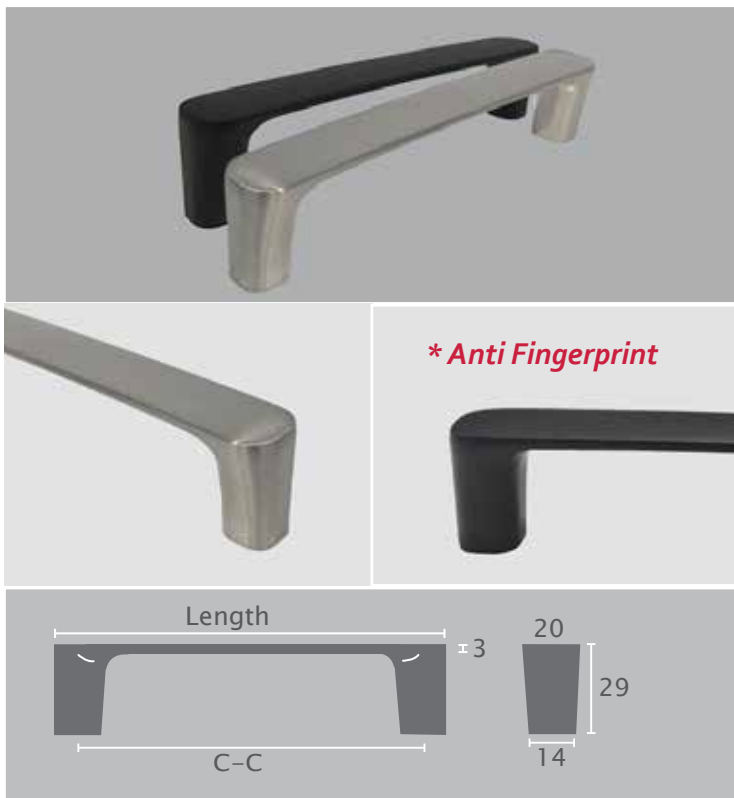

H047 Bollard Handle

Material: Zn-Alloy

Item No.	Finish	C-C	L
H047-128MB	Matt Black	128	143
H047-192MB	Matt Black	192	207
H047-320MB	Matt Black	320	335
H047-128SN	Satin Nickel	128	143
H047-192SN	Satin Nickel	192	207
H047-320SN	Satin Nickel	320	335

Finish



Satin Nickel



Matt Black

*M4 Screws Included



K047 Bollard Knob

Material: zn-Alloy

Item No.	Finish	H	W
K047-MB	Matt Black	25	43
K047-MN	Matt Nickel	25	43

Finish



Matt Nickel



Matt Black

*M4 Screws Included

Sign Up

to check prices & order online

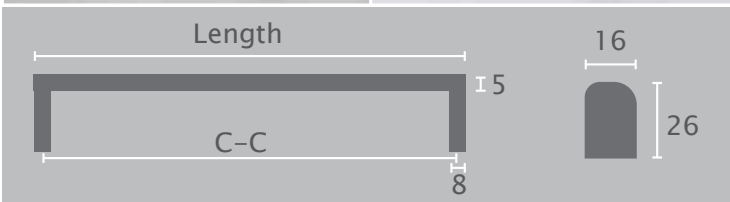

H906 Radius Top Handle

Material: Zn-Alloy

Item No.	C-C	Length
H906-128	128	136
H906-160	160	168
H906-192	192	200
H906-256	256	264
H906-416	416	424

Finish



Satin
Nickel

*M4 Screws Included

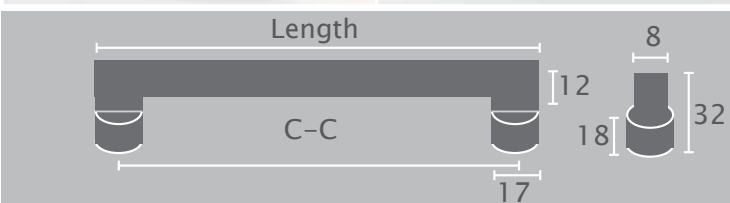

H822 Hurdle Handle

Material: Zn-Alloy

Item No.	C-C	Length
H882-128	128	146
H882-160	160	178
H882-224	224	242
H882-320	320	338

Finish



Satin
Nickel

*M4 Screws Included

Sign Up

to check prices & order online



H927-128MB Luxe Bow Handle

Material: Zn-Alloy

Item No.	C-C	Length
H927-128MB	128	162
Finish	 Matt Black	

*M4 Screws Included



H926-128MB Luxe Twist Handle

Material: Zn-Alloy

Item No.	C-C	Length
H926-128MB	128	160
Finish	 Matt Black	

*M4 Screws Included

Sign Up to check prices & order online

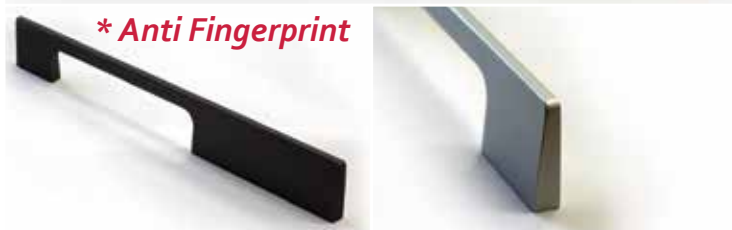

H461 Slim Tapered Profile Handle

Material: Aluminium

Item No.	C-C	Length
H461-224MC	224	250
H461-320MC	320	346
H461-192MB	192	218
H461-320MB	320	346

Finish

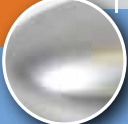

Matt
Chrome



Matt
Black

*M4 Screws Included

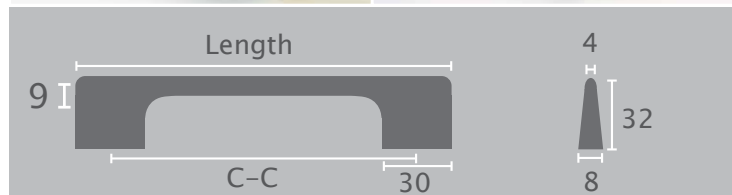

H462 Slim Tapered Profile Handle

Material: Aluminium

Item No.	C-C	Length
H462-128MB	128	158
H462-160MB	160	190
H462-224MB	224	254
H462-320MB	320	350

Finish



Matt
Black

*M4 Screws Included

Sign Up

to check prices & order online

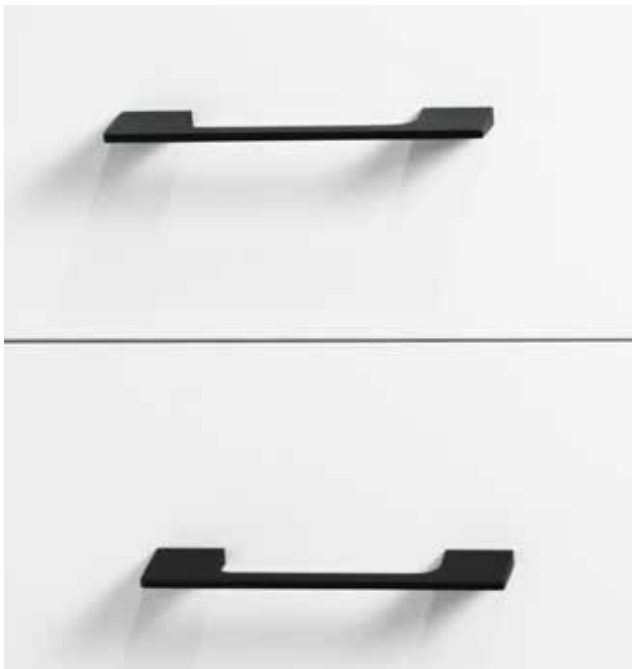

Sign Up

to check prices & order online

www.eurofit.com.au

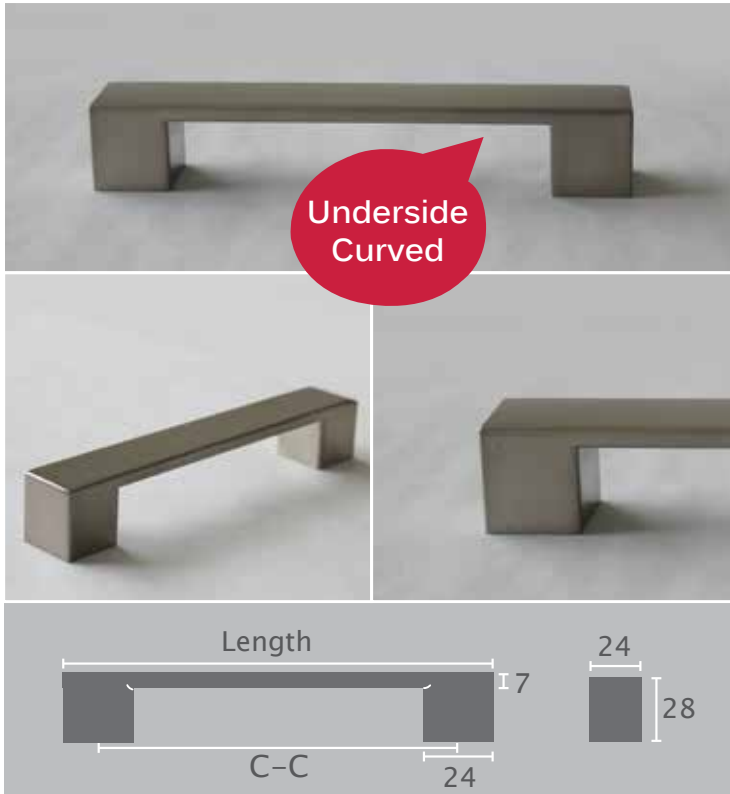

H322 Plank Square Handle

Material: Zn-Alloy

Item No.	C-C	Length
H322-128	128	158
H322-160	160	190
H322-224	224	254
H322-320	320	350
H322-416	416	446

Finish



Satin Nickel

*M4 Screws Included

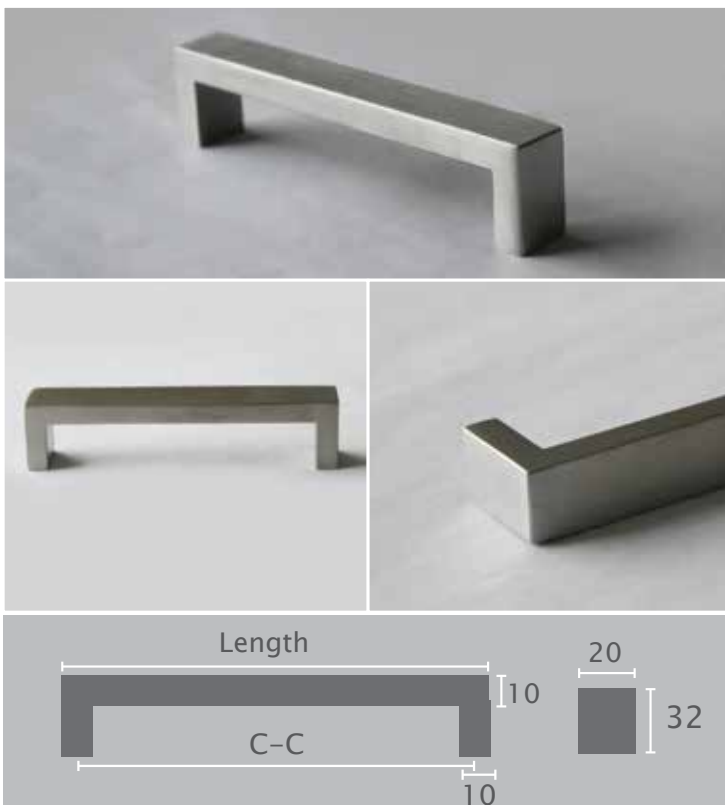

H503 Flat Square Block Handle

Material: 304 Stainless Steel

Item No.	C-C	Length
H503-128	128	138
H503-160	160	170
H503-224	224	234
H503-320	320	330
H503-416	416	426
H503-608	608	618

Finish



Satin Nickel

*M4 Screws Included

Sign Up

to check prices & order online

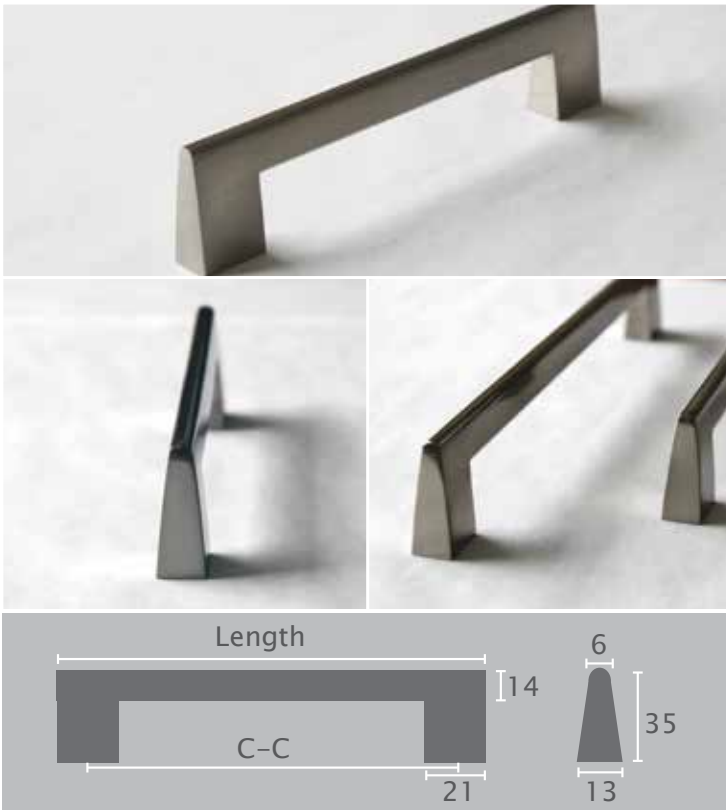

H004 Pyramid Handle

Material: Zn-Alloy

Item No.	C-C	Length
H004-128	128	158
H004-160	160	190
H004-224	224	254
H004-320	320	350
H004-416	416	446

Finish



Satin
Nickel

*M4 Screws Included



H401 Saddle-Back Cylinder Handle

Material: 304 Stainless Steel

Item No.	C-C	Length
H401 - 96	96	108
H401-128	128	140
H401-160	160	172
H401-192	192	204
H401-224	224	236
H401-320	320	332
H401-416	416	428
H401-608	608	620

Finish



Satin
Nickel

*M4 Screws Included

Sign Up

to check prices & order online

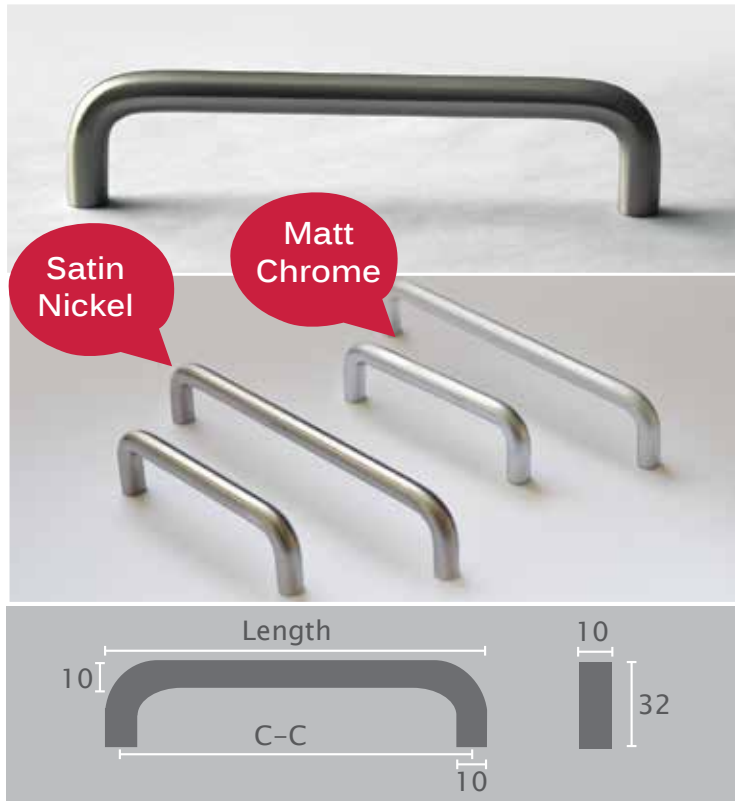

H044 Standard D Handle

Material: Solid Steel

Item No.	Finish	C-C	L
H044-96	Satin Nickel	96	106
H044-128	Satin Nickel	128	138
H044-160	Satin Nickel	160	170
H044-224	Satin Nickel	224	234
H044-288	Satin Nickel	288	298
H044-352	Satin Nickel	352	362
H044-96MC	Matt Chrome	96	106
H044-128MC	Matt Chrome	128	138
H044-160MC	Matt Chrome	160	170
H044-224MC	Matt Chrome	224	234
H044-352MC	Matt Chrome	352	362



*M4 Screws Included

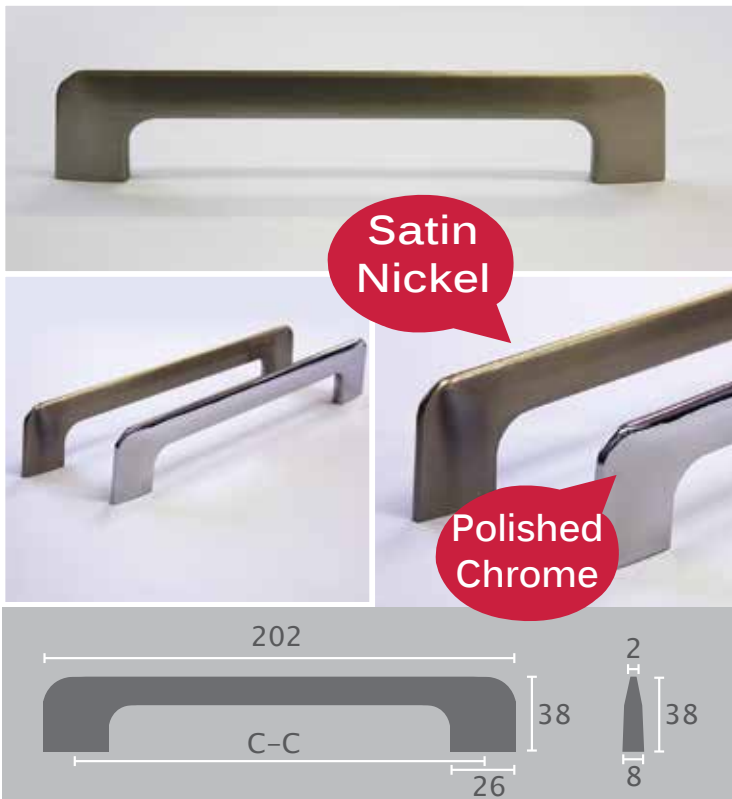

H978 Flair D Handle

Material: Zn-Alloy

Item No.	Finish	C-C	Length
H978-160	Satin Nickel	160	202
H978-160C	Polished Chrome	160	202



*M4 Screws Included

Sign Up to check prices & order online

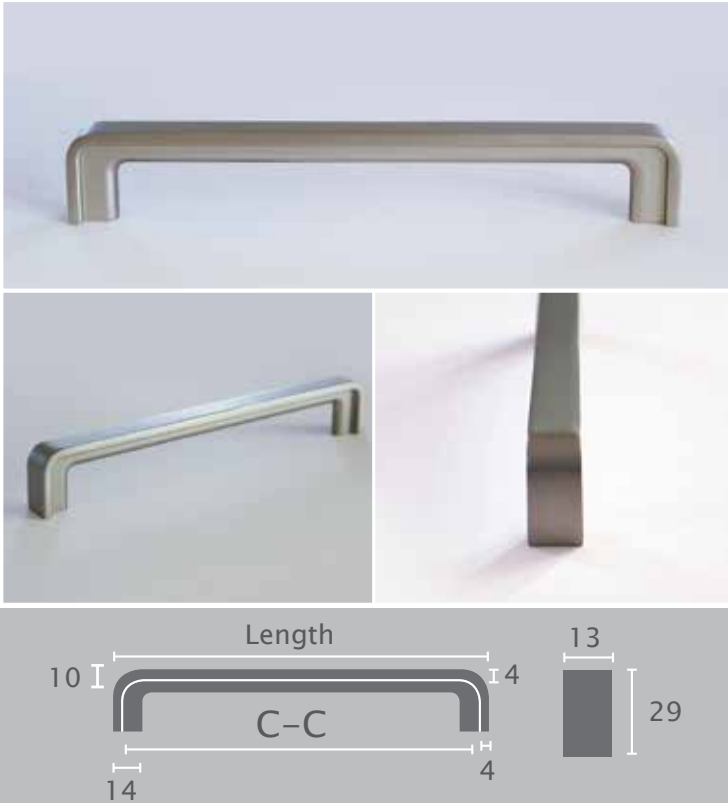

H364 Rebate Round Corner D Handle

Material: Zn-Alloy

Item No.	C-C	Length
H364-160	160	178
Finish	Satin Nickel	

*M4 Screws Included

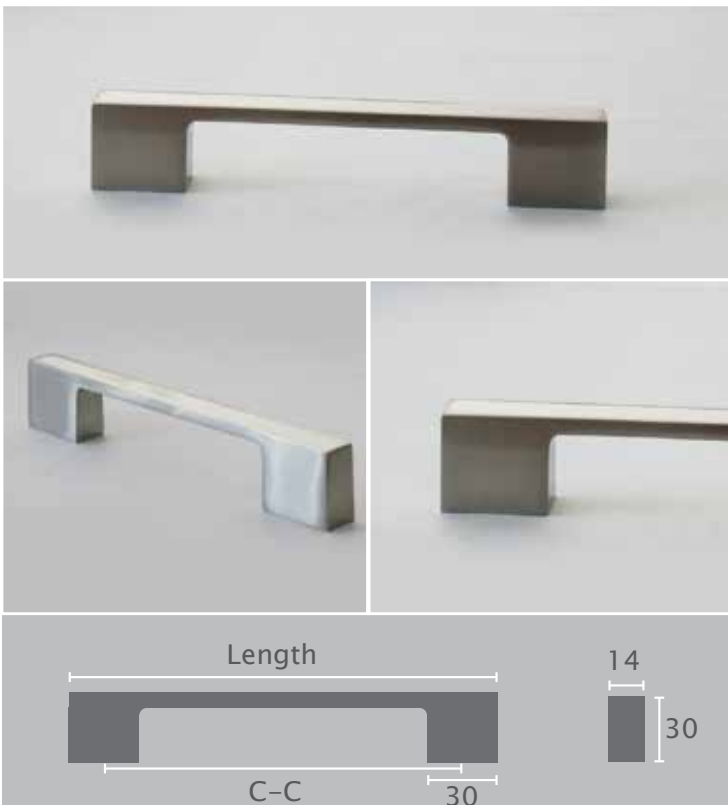

H108 Bridge Handle

Material: Zn-Alloy

Item No.	C-C	Length
H108 - 96	96	136
H108-128	128	158
H108-160	160	190
H108-224	224	254
H108-320	320	350
H108-416	416	446
Finish	Satin Nickel	

*M4 Screws Included

Sign Up

to check prices & order online

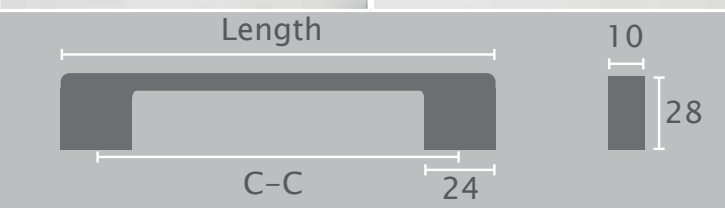
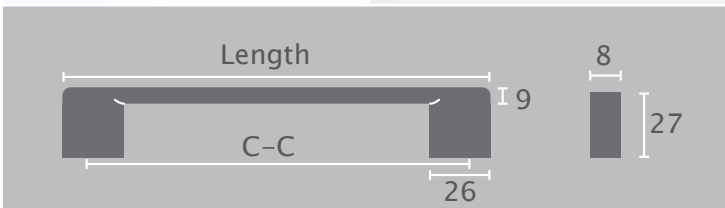

H904 Slim Profile Handle

Material: Zn-Alloy

Item No.	Finish	C-C	Length
H904 - 96	Satin Nickel	96	132
H904-128	Satin Nickel	128	164
H904-160	Satin Nickel	160	195
H904-192	Satin Nickel	192	228
H904-224	Satin Nickel	224	258
H904-256	Satin Nickel	256	292
H904-320	Satin Nickel	320	358
H904-416	Satin Nickel	416	452
H904-128MB	Matt Black	128	164
H904-160MB	Matt Black	160	195
H904-192MB	Matt Black	192	228
H904-224MB	Matt Black	224	258
H904-320MB	Matt Black	320	358
H904-160G	Brushed Gold	160	195
H904-224G	Brushed Gold	224	258
H904-320G	Brushed Gold	320	358



*M4 Screws Included

H265 Strip Line Handle

Material: Zn-Alloy / ABS

Item No.	C-C	Length	Strip Colour
H265W -128	128	169	White
H265 B -128	128	169	Black

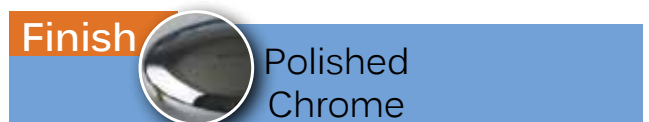

*M4 Screws Included

Sign Up to check prices & order online



Sign Up

to check prices & order online

www.eurofit.com.au

30

T: 03 8592 1955

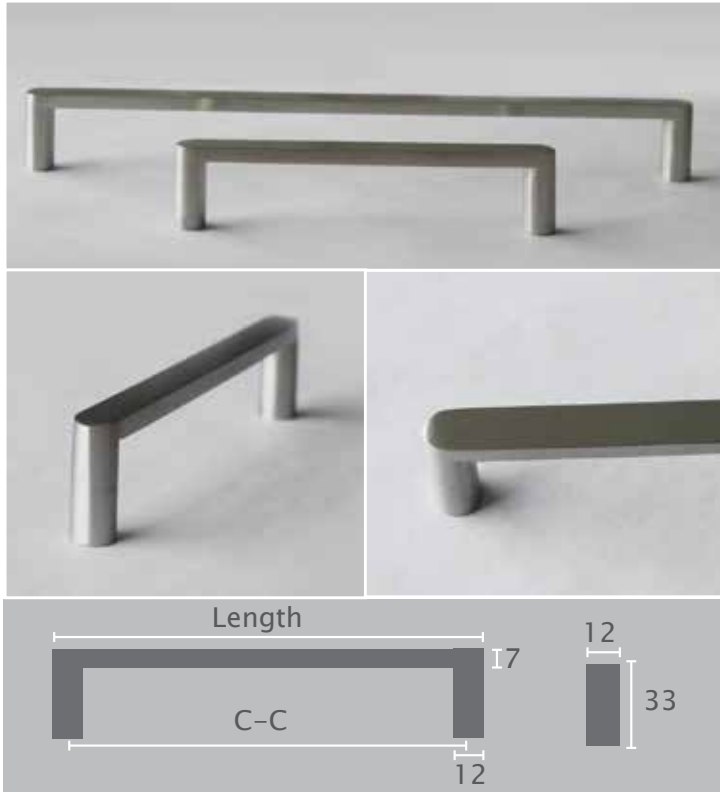

H601 Flat Cylinder Handle

Material: 304 Stainless Steel

Item No.	C-C	Length
H601 - 96	96	108
H601-128	128	140
H601-160	160	172
H601-192	192	204
H601-256	256	268
H601-320	320	332
H601-416	416	428

Finish



Satin
Nickel

*M4 Screws Included

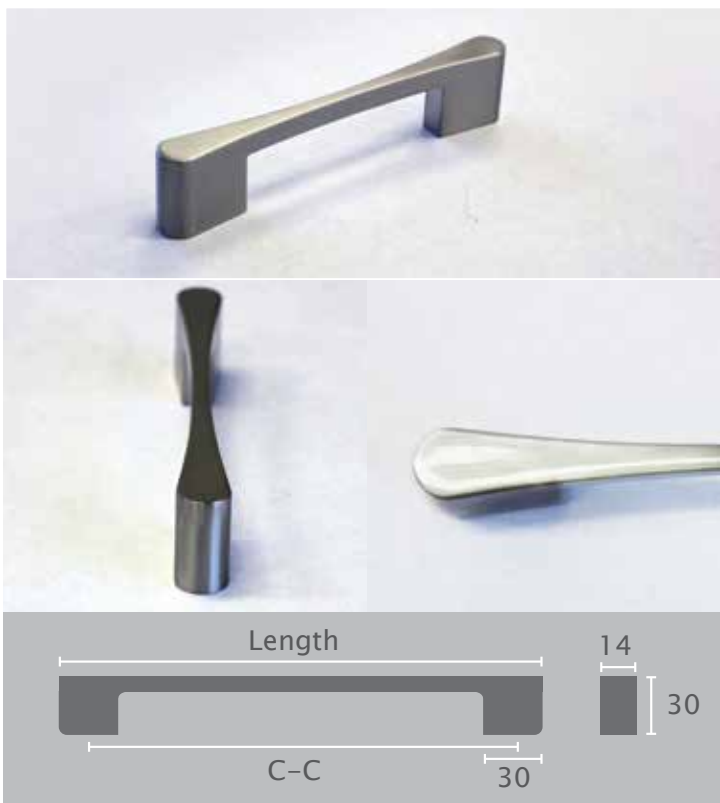

H023 Tapered Flat Handle

Material: Zn-Alloy

Item No.	C-C	Length
H023-128	128	140
H023-224	224	232
H023-320	320	328

Finish



Satin
Nickel

*M4 Screws Included

Sign Up

to check prices & order online

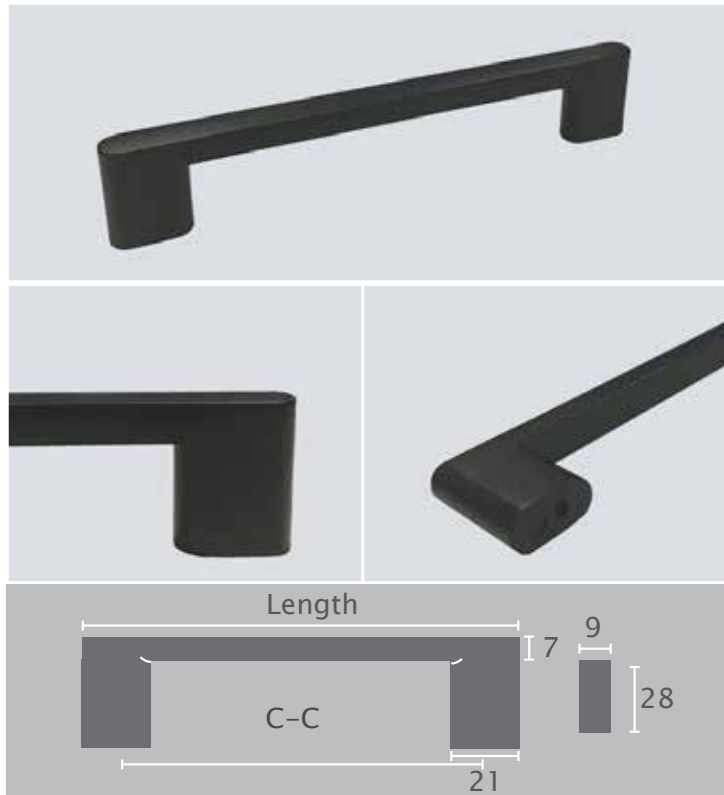

H570 Round Corner Slim Profile Handle

Material: Aluminium

Item No.	Finish	C-C	L
H570-128MB	Matt Black	128	152
H570-192MB	Matt Black	192	216

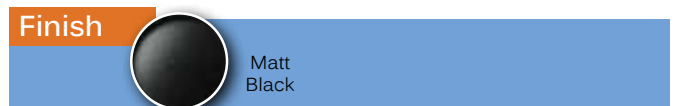

*M4 Screws Included

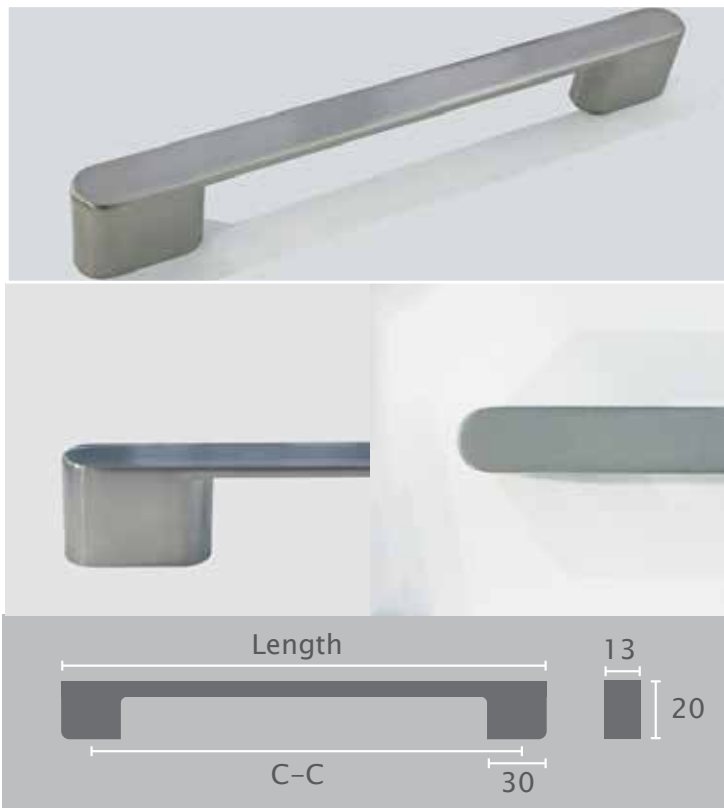

H333-160 Harper Handle

Material: Zn-Alloy

Item No.	C-C	Length
H333-160	160	180
H333-224	224	244
H333-320	320	340
H333-416	416	436

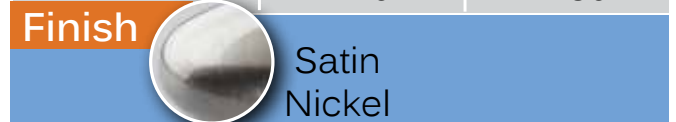

*M4 Screws Included

Sign Up to check prices & order online

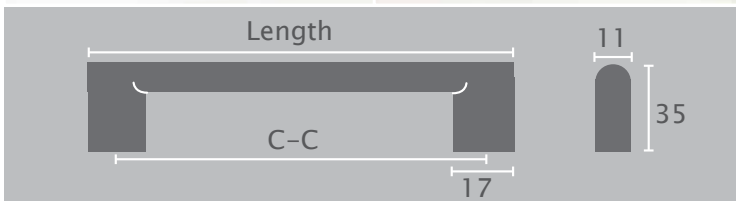

H852 Oval Bar Handle

Material: Zn-Alloy

Item No.	C-C	Length
H852-128	128	145
H852-160	160	177
H852-224	224	241
H852-320	320	337
H852-416	416	436

Finish



Satin Nickel

*M4 Screws Included

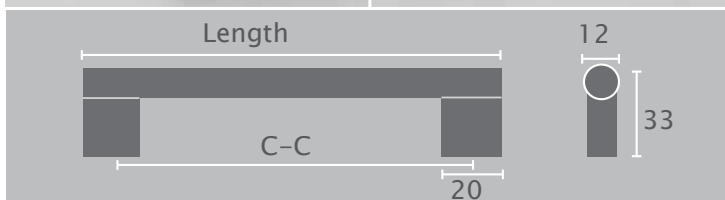
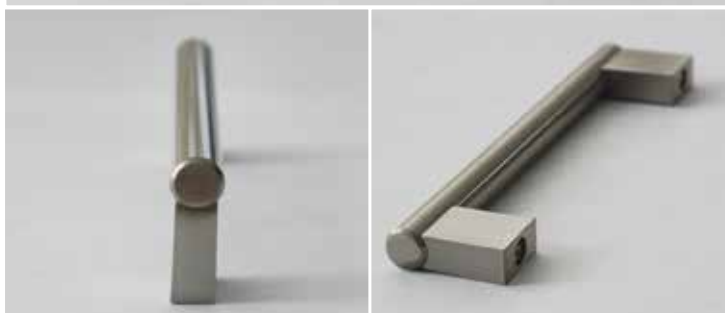

H301 Square Post Bar Handle

Material: Bar (Solid Steel)/ Foot (Zn-Alloy)

Item No.	C-C	Length
H301-128	128	150
H301-160	160	182
H301-224	224	246
H301-320	320	342
H301-416	416	438
H301-608	608	630

Finish



Satin Nickel

*M4 Screws Included

Sign Up

to check prices & order online

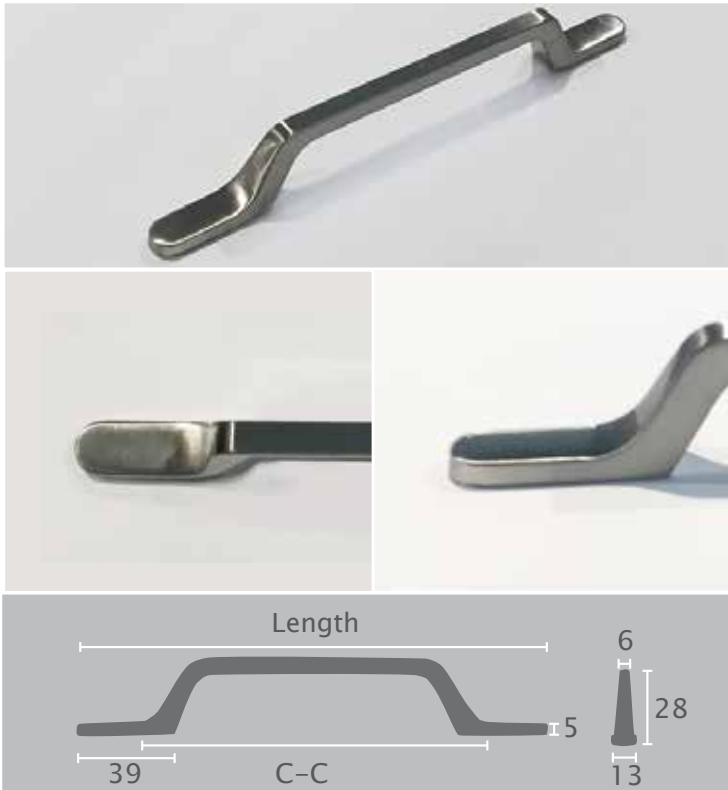

H688 Flat Feet Handle

Material: Zn-Alloy

Item No.	C-C	Length
H688-128	128	195
H688-160	160	227
H688-224	224	291
H688-320	320	387

Finish  Satin Nickel



*M4 Screws Included



H625 Contour Handle

Material: Zn-Alloy

Item No.	C-C	Length
H625-128	128	138
H625-160	160	170
H625-224	224	234
H625-320	320	330
H625-128MB	128	138
H625-160MB	160	170
H625-224MB	224	234
H625-320MB	320	330

Finish  Satin Nickel  Matt Black

*M4 Screws Included

Sign Up to check prices & order online



Sign Up to check prices & order online

www.eurofit.com.au



K368 Table Knob

Material: Zn-Alloy

Item No.	Finish	H	D
K368	Satin Nickel	28	34
K368-MB	Matt Black	28	34
K368-G	Brushed Gold	28	34
K368-MWH	Matt White	28	34

Finish	Image	Finish	Image
Satin Nickel		Brushed Gold	
Matt White		Matt Black	

*M4 Screws Included



H367 Table Handle

Material: Zn-Alloy

Item No.	Finish	C-C	L
H367-160	Satin Nickel	160	184
H367-224	Satin Nickel	224	249
H367-160MB	Matt Black	160	184
H367-224MB	Matt Black	224	249
H367-160G	Brushed Gold	160	184
H367-224G	Brushed Gold	224	249
H367-160MWH	Matt White	160	184

Finish	Image	Finish	Image
Satin Nickel		Brushed Gold	
Matt White		Matt Black	

*M4 Screws Included

Sign Up to check prices & order online

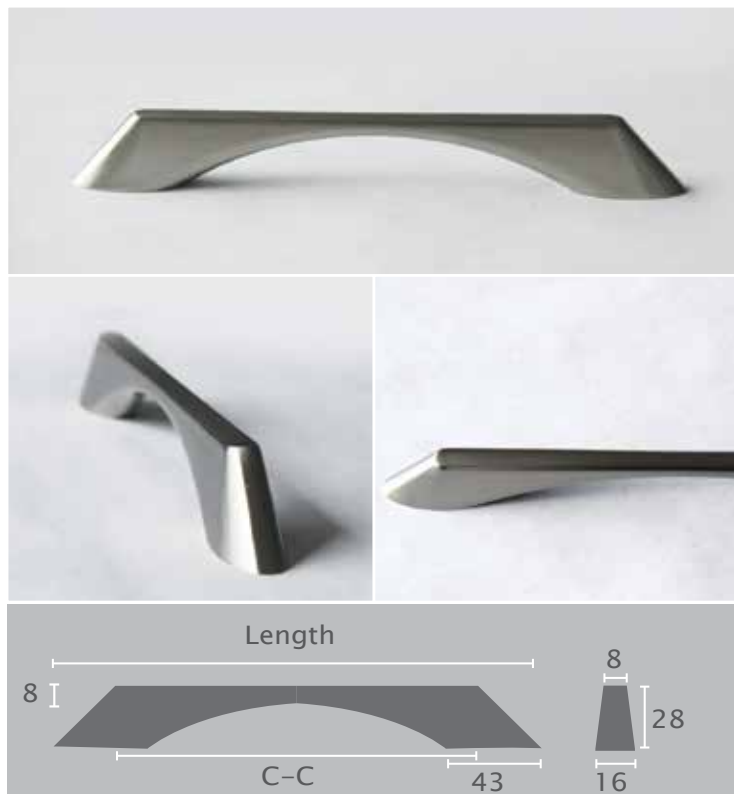

H258 Moustache Handle

Material: Zn-Alloy

Item No.	C-C	Length
H258-160	160	198
H258-224	224	272

Finish



Satin
Nickel

*M4 Screws Included

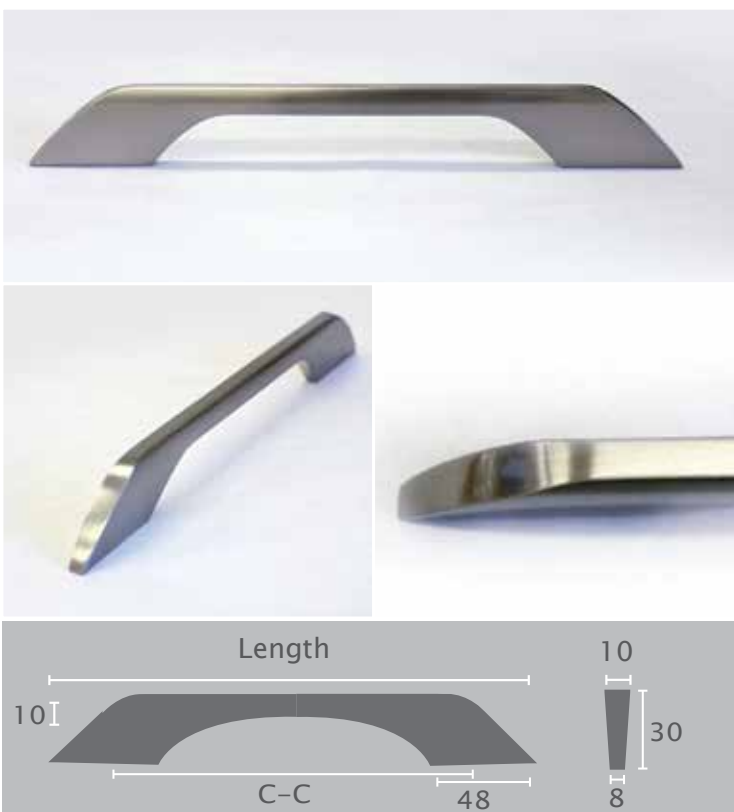

H105 Flair Moustache Handle

Material: Zn-Alloy

Item No.	C-C	Length
H105-320	320	368

Finish



Satin
Nickel

*M4 Screws Included

Sign Up

to check prices & order online

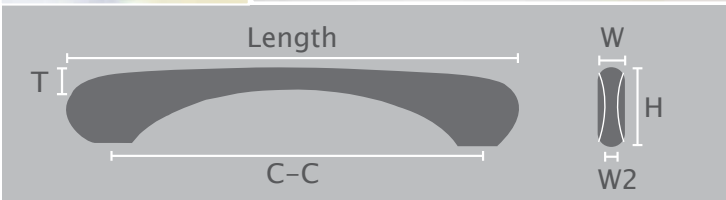

H260 Wishbone Handle

Material: Zn-Alloy

Item No.	C-C	Length	H	W	W2	T
H260-128	128	164	30	9	5	8
H260-160	160	195	32	9	6	8
H260-224	224	266	33	10	6	10

Finish  Satin Nickel

*M4 Screws Included

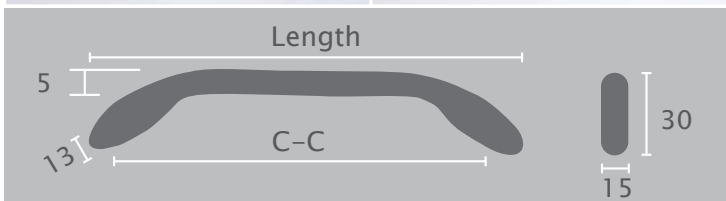

H263 Gondola Handle

Material: Zn-Alloy

Item No.	C-C	Length
H263-128	128	144
H263-160	160	172
H263-192	192	208
H263-320	320	335

Finish  Satin Nickel

*M4 Screws Included

Sign Up to check prices & order online



H801 Slim Bow Handle

Material: Zn-Alloy

Item No.	C-C	Length
H801-128	128	161
H801-160	160	193
H801-224	224	257
H801-320	320	353

Finish  Satin Nickel

*M4 Screws Included

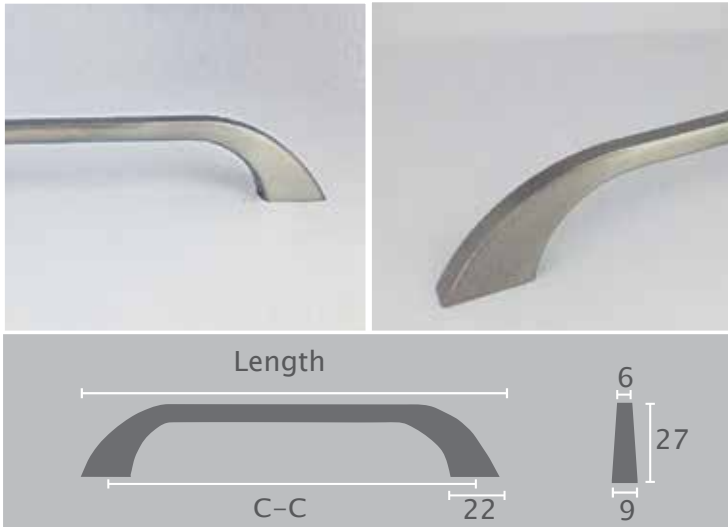

H158 Tapered Mercury Handle

Material: Zn-Alloy

Item No.	C-C	Length
H158-160	160	205

Finish  Satin Nickel

*M4 Screws Included

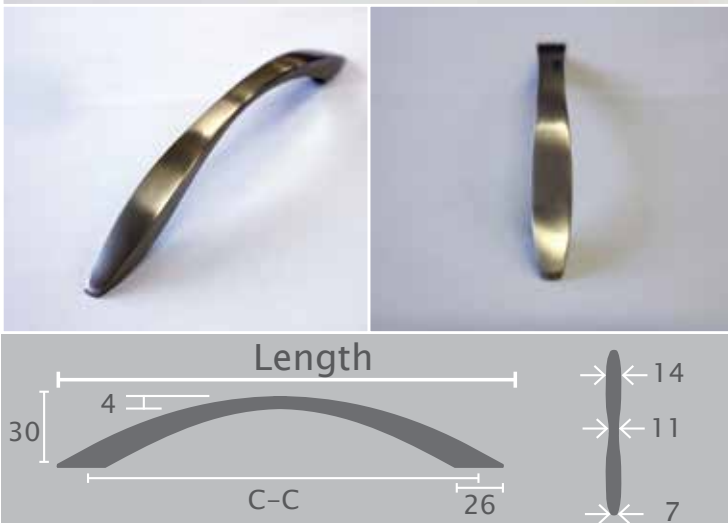

Sign Up to check prices & order online



H269 Surfboard Handle

Material: Zn-Alloy

Item No.	C-C	Length
H269-128	128	155
Finish	 Satin Nickel	

*M4 Screws Included

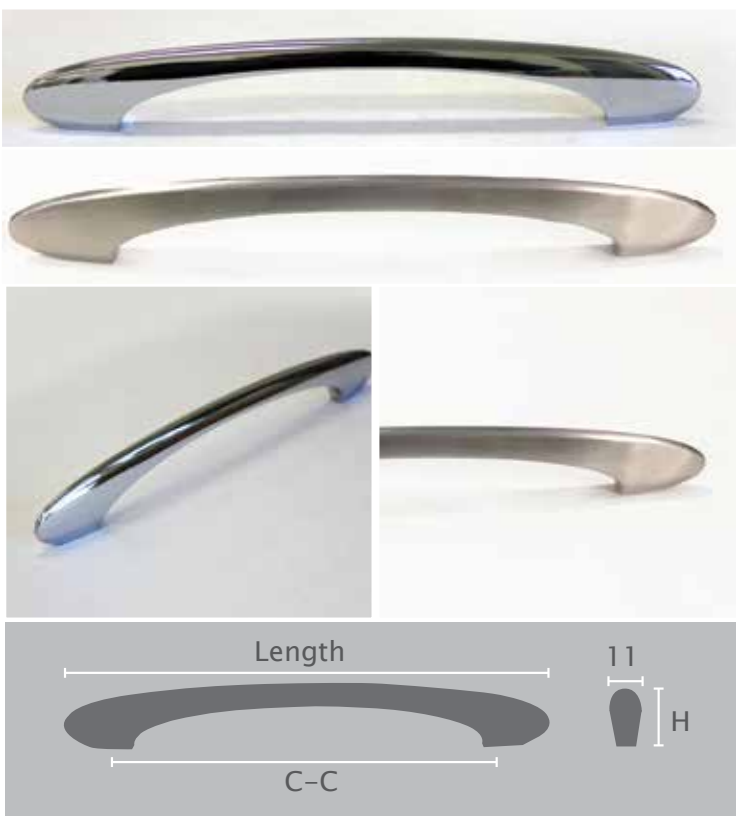

H133 Mercury Handle

Material: Zn-Alloy

Item No.	C-C	Length	H
H133-160C	160	210	29
H133-224C	224	295	33
H133-160	160	210	29
H133-192	192	250	31
H133-256	256	330	34
Finish	 Polished Chrome  Satin Nickel		

*M4 Screws Included

Sign Up

to check prices & order online



H901 Flat-Arc Handle

Material: Zn-Alloy

Item No.	C-C	Length
H901-128	128	156
H901-160	160	189
H901-192	192	221
H901-224	224	253

Finish  Satin Nickel

*M4 Screws Included

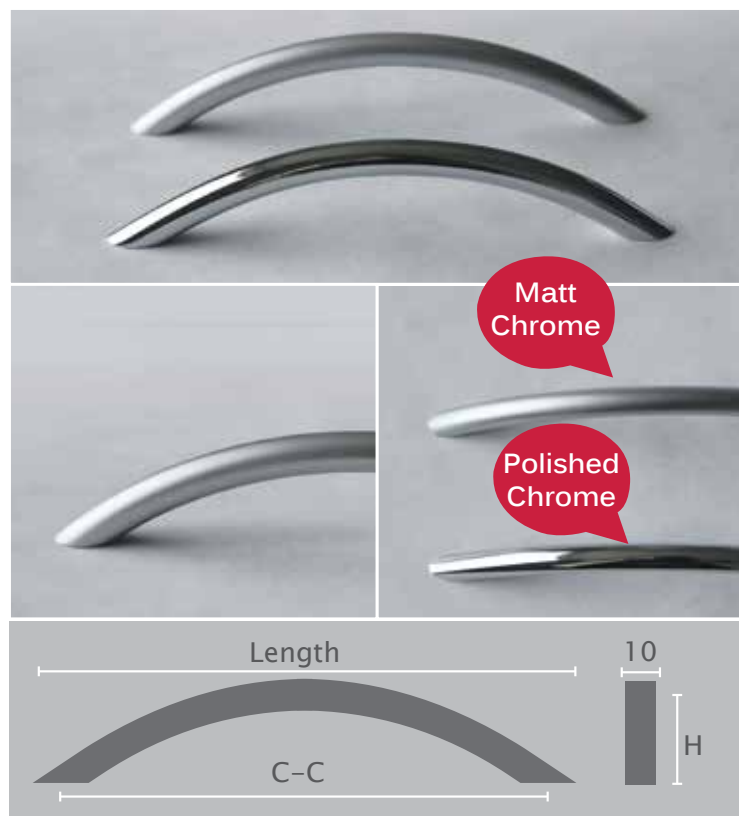

H042 Standard Bow Handle

Material: Zn-Alloy

Item No.	Finish	C-C	L	H
H042 - 96C	Polished Chrome	96	116	30
H042-128C	Polished Chrome	128	154	28
H042 - 96MC	Matt Chrome	96	116	30
H042-128MC	Matt Chrome	128	154	28

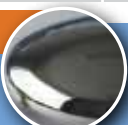
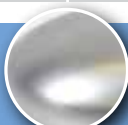
Finish  Polished Chrome  Matt Chrome

*M4 Screws Included

Sign Up to check prices & order online

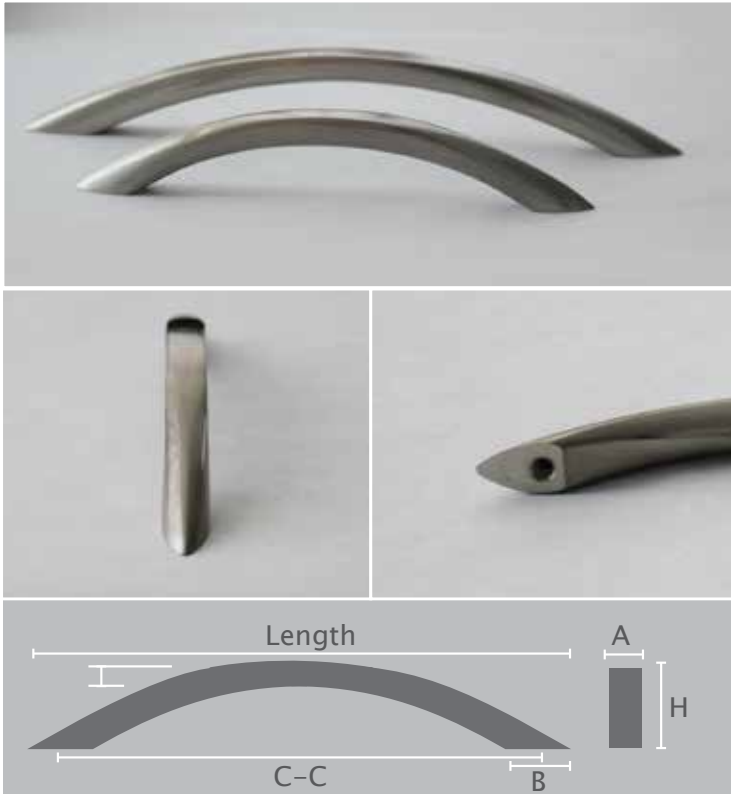

H048 Flat Top Bow Handle

Material: Zn-Alloy

Item No.	C-C	A	B	H	Length
H048-128	128	12	20	26	160
H048-192	192	14	26	32	228

Finish



Satin Nickel

*M4 Screws Included

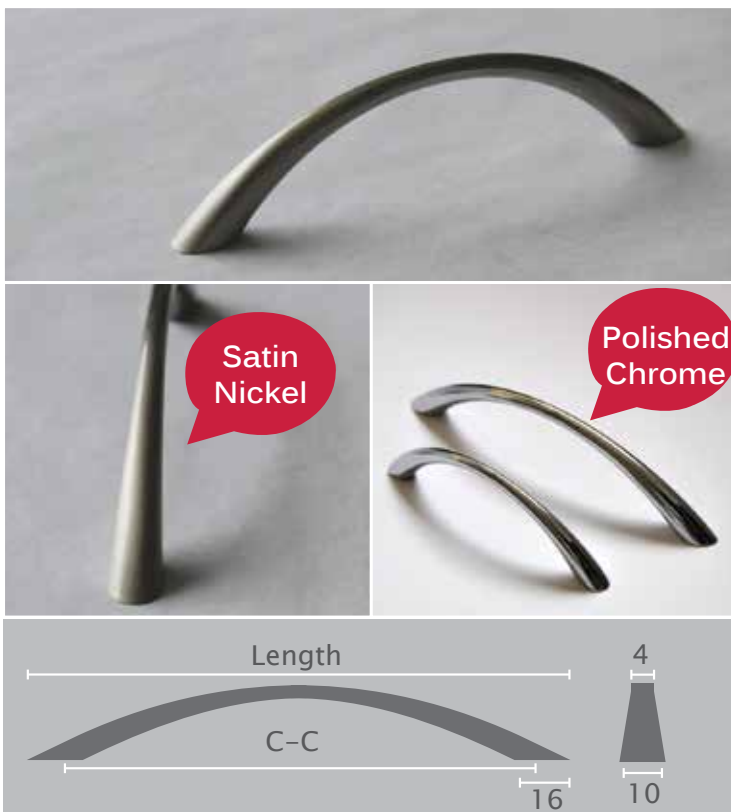

H001 Tapered Bow Handle

Material: Zn-Alloy

Item No.	Finish	C-C	L
H001-96	Satin Nickel	96	116
H001-128	Satin Nickel	128	147
H001-96C	Polished Chrome	96	116
H001-128C	Polished Chrome	128	147

Finish



Satin Nickel



Polished Chrome

*M4 Screws Included

Sign Up

to check prices & order online

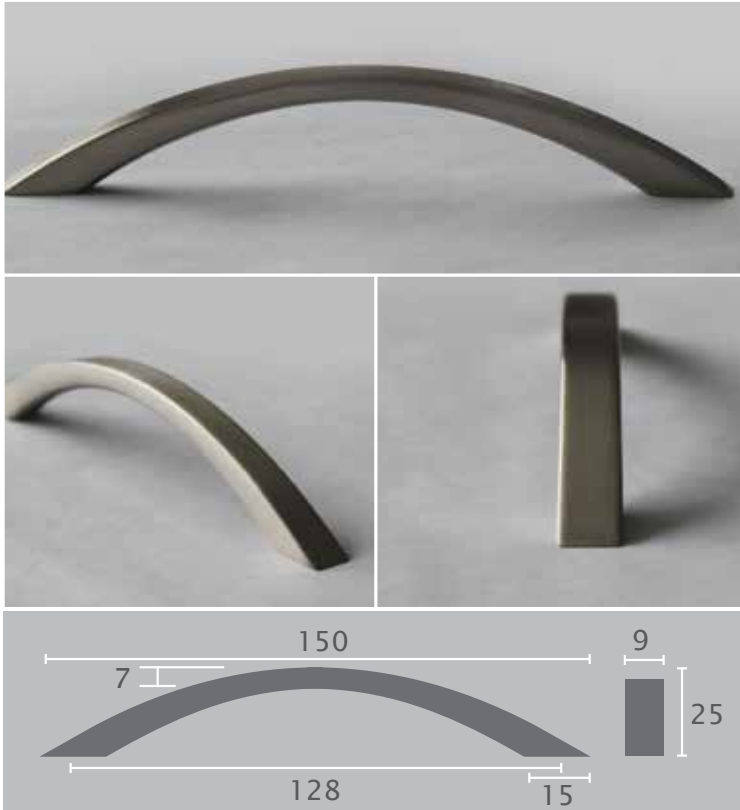

H045 Square Arc Handle

Material: Zn-Alloy

Item No.	C-C	Length
H045-128	128	150

Finish



Satin
Nickel

*M4 Screws Included



H068 Bill Handle

Material: Zn-Alloy

Item No.	C-C	Length
H068-128	128	160

Finish



Satin
Nickel

*M4 Screws Included

Sign Up

to check prices & order online



H161 Echidna Handle

Material: Zn-Alloy

Item No.	C-C	Length
H161-96MC	96	139
Finish	 Matt Chrome	

*M4 Screws Included

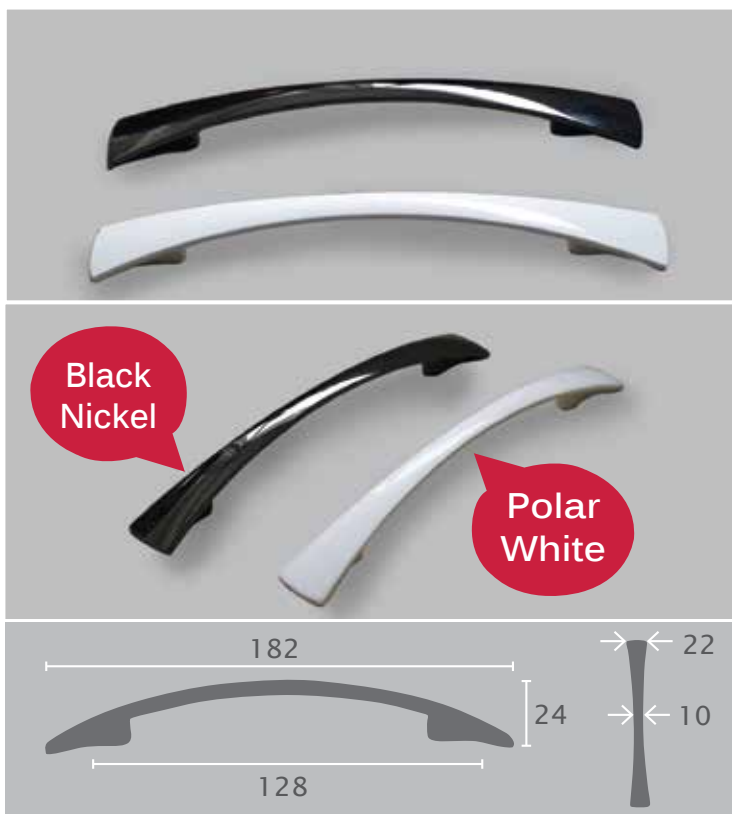

H268 Bow Tie Handle

Material: Zinc Alloy

Item No.	Finish	C-C	L
H268B-128	Black Nickel	128	182
H268W-128	Polar White	128	182
Finish	 Black Nickel  Polar White		

*M4 Screws Included

Sign Up

to check prices & order online



H359 Royale Handle

Material: Zn-Alloy

Item No.	Finish	C-C	L
H359-128P	Pewter	128	140
H359-128MB	Matt Black	128	140

Finish

	Pewter		Matt Black
---	--------	--	------------

*M4 Screws Included



K38 Royale Knob

Material: Zn-Alloy

Item No.	Finish	H	L
K38-P	Pewter	23	30
K38-MB	Matt Black	23	30

Finish

	Pewter		Matt Black
--	--------	---	------------

*M4 Screws Included

Sign Up

to check prices & order online



H213 Antique Ceramic D Handle

Material: Ceramic + Zn-Alloy

Item No.	C-C	Length
H213-128	128	153
Finish	 White Ceramic	 Pewter

*M4 Screws Included



K46 Antique Ceramic T Knob

Material: Ceramic + Zn-Alloy

Item No.	H	Length
K46	47	75
Finish	 White Ceramic	 Pewter

*M4 Screws Included

Sign Up

to check prices & order online



K84 Antique Ceramic Knob

Material: Ceramic + Zn-Alloy

Item No.	H	Length
K84	33	37

Finish	White Ceramic	Pewter

*M4 Screws Included



H815 Pipe Handle

Material: Zn-Alloy

Item No.	Finish	C-C	L
H815-128MB	Matt Black	128	142
H815-192MB	Matt Black	192	206
H815-320MB	Matt Black	320	334
H815-128PK	Gunmetal	128	142
H815-192PK	Gunmetal	192	206
H815-320PK	Gunmetal	320	334
H815-128G	Brushed Gold	128	142
H815-192G	Brushed Gold	192	206
H815-320G	Brushed Gold	320	334

Finish	Gunmetal	Matt Black	Brushed Gold

*M4 Screws Included

Sign Up to check prices & order online



Sign Up to check prices & order online

www.eurofit.com.au

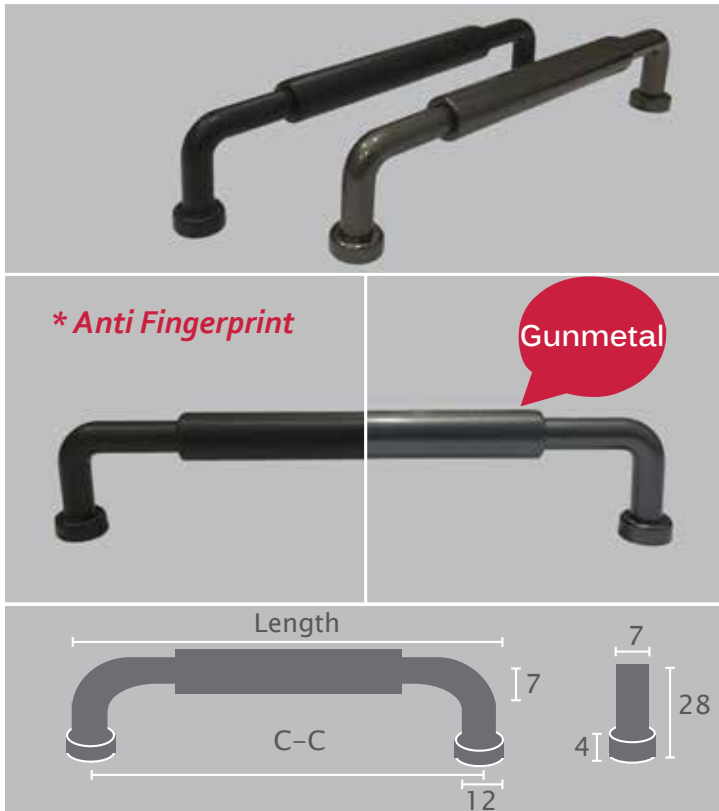

H508 Pipe Handle with Sleeve

Material: Zn-Alloy

Item No.	Finish	C-C	L
H508-128MB	Matt Black	128	140
H508-192MB	Matt Black	192	204
H508-320MB	Matt Black	320	332
H508-128PK	Gunmetal	128	140
H508-192PK	Gunmetal	192	204
H508-320PK	Gunmetal	320	332



*M4 Screws Included



K508 Pipe T-bar Knob with Sleeve

Material: zn-Alloy

Item No.	Finish	H	W
K508-MB	Matt Black	30	50
k508-PK	Gunmetal	30	50

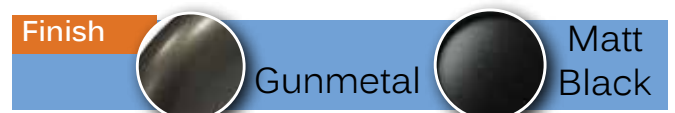

*M4 Screws Included

Sign Up to check prices & order online

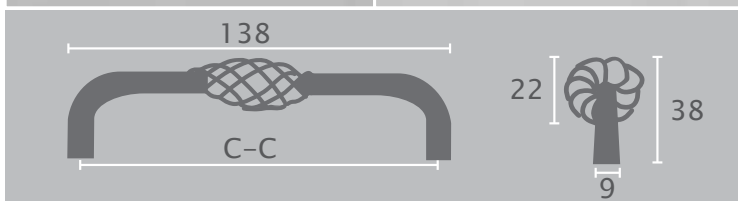

H145 Antique Bird Nest D Handle

Material: Steel

Item No.	Finish	C-C	L
H145-128P	Pewter	128	138
H145-128MB	Matt Black	128	138

Finish



Pewter



Matt Black

*M4 Screws Included

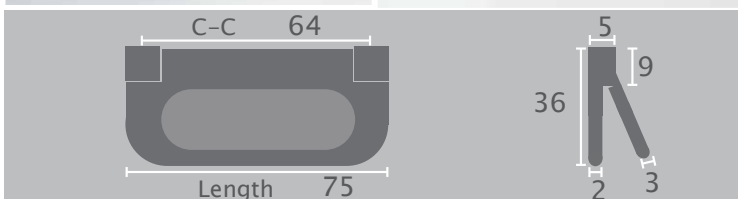

P300 Flat Ring Pull

Material: Zn-Alloy

Item No.	C-C	Length
P300-64	64	75

Finish



Satin Nickel

*M4 Screws Included

Sign Up

to check prices & order online

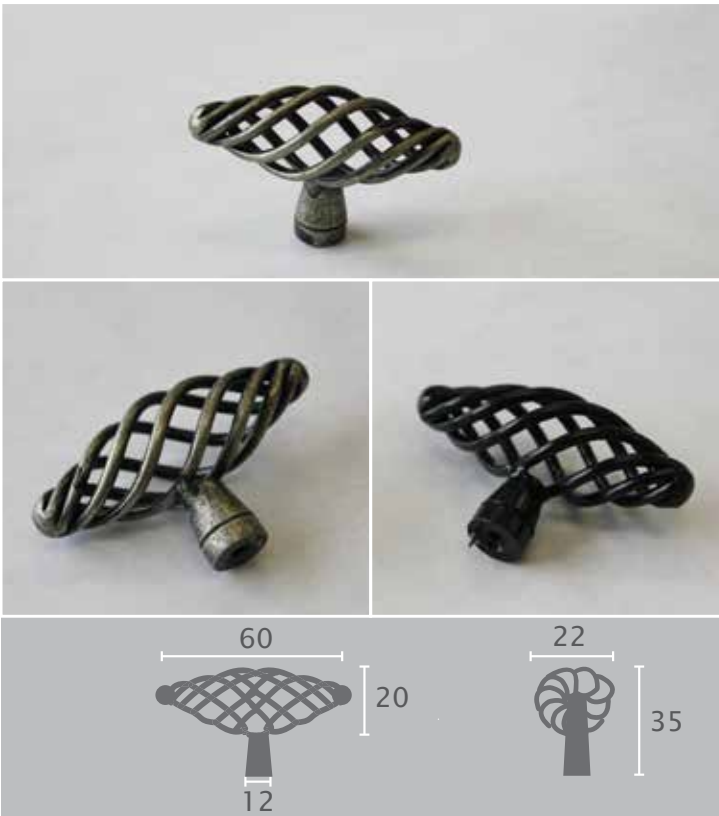

K59 Antique Bird Nest Knob

Material: Steel

Item No.	Finish	H	L
K59-P	Pewter	35	60
K59-MB	Matt Black	35	60

Finish



Pewter



Matt Black

*M4 Screws Included



H148 Antique Bird Nest Swivel Handle

Material: Steel

Item No.	Finish	C-C	L
H148-128P	Pewter	128	140
H148-128MB	Matt Black	128	140

Finish



Pewter



Matt Black

*M4 Screws Included

Sign Up

to check prices & order online



Sign Up

to check prices & order online

www.eurofit.com.au



P471 Shell-like Finger Pull

Material: Zn-Alloy

Item No.	Finish	C-C
P471-MB	Matt Black	76
P471-P	Pewter	76

Finish



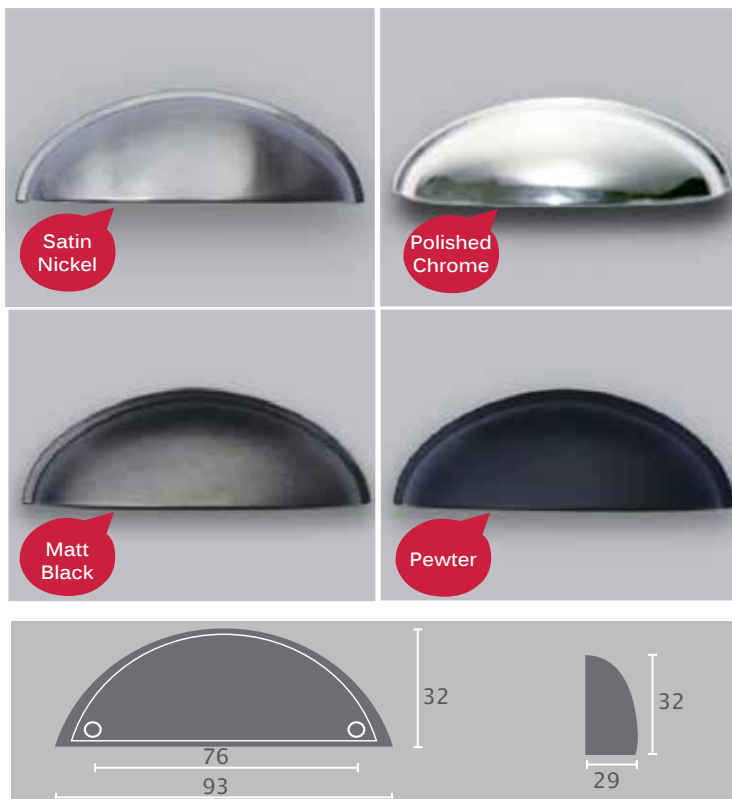

*M4 Screws Included



P427 Crescent Finger Pull

Material: Zn-Alloy

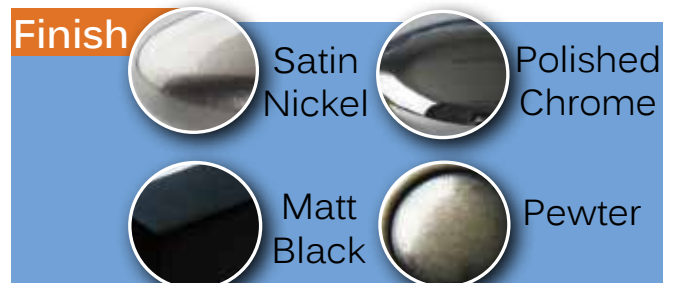
Item No.	Finish	C-C
P427	Satin Nickel	76
P427-MB	Matt Black	76
P427-P	Pewter	76
P427-C	Polished Chrome	76



*M4 Screws Included

Sign Up to check prices & order online





P265 Hampton Cup Pull

Material: Zn-Alloy

Item No.	Finish	C-C	L
P265	Satin Nickel	64	85
P265-MB	Matt Black	64	85

Finish

	Satin Nickel		Matt Black
---	--------------	--	------------

*M4 Screws Included



H266 Case Handle

Material: Zn-Alloy

Item No.	Finish	C-C	H
H266-96	Satin Nickel	96	24
H266-96MB	Matt Black	96	24

Finish

	Satin Nickel		Matt Black
--	--------------	---	------------

*M4 Screws Included

Sign Up

to check prices & order online



Sign Up to check prices & order online



K179 Antique Classic Ring Knob

Material: Zn-Alloy

Item No.	Finish	H	D
K179-P	Pewter	25	32
K179-MB	Matt Black	25	32

Finish



Pewter



Matt Black

*M4 Screws Included



H225 Georgian Handle

Material: Zn-Alloy

Item No.	Finish	C-C	L
H225-160MB	Matt Black	160	173
H225-256MB	Matt Black	256	269

Finish



Matt Black

*M4 Screws Included



Sign Up to check prices & order online

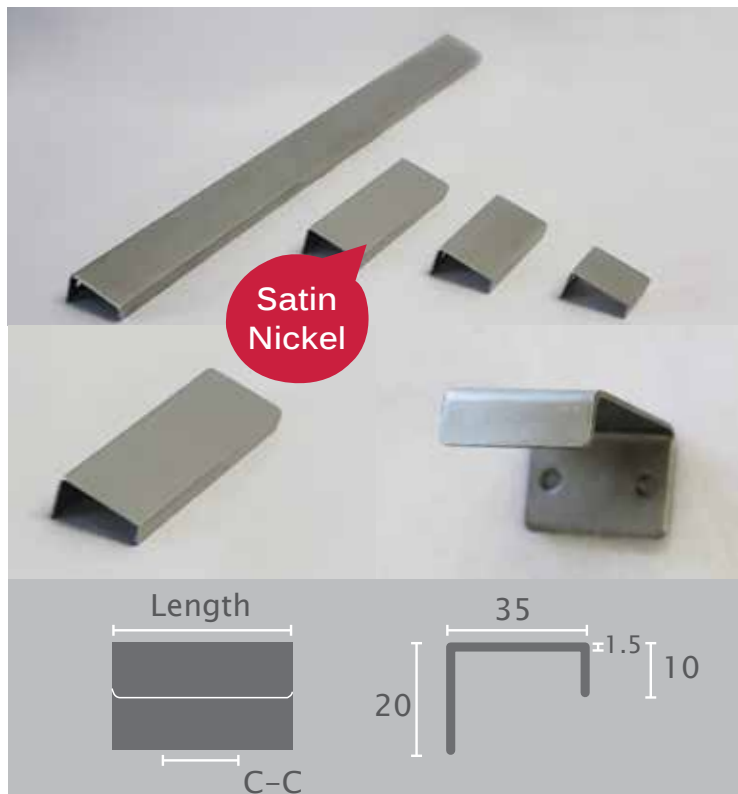

P17 L-Shaped Finger Pull

Material: 304 Stainless Steel

Item No.	C-C	Length
P17 - 30	15	30
P17 - 70	50	70
P17-100	64	100
P17-200	160	200
P17-300	256	300
P17-400	384	400
P17-500	480	500

Finish Satin Nickel

*16mm Partical Board Screws Included

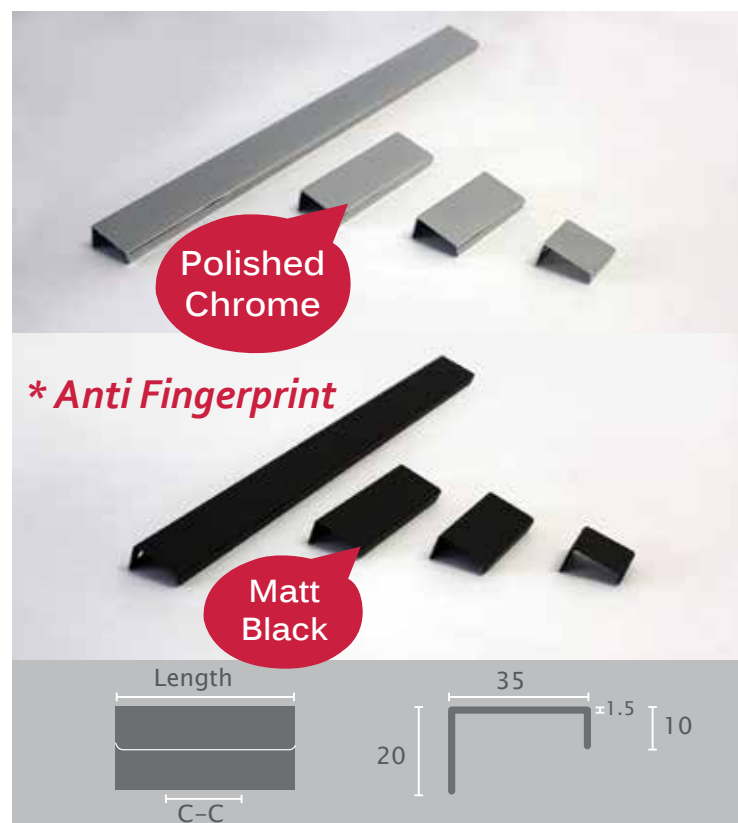

P17 L-Shaped Finger Pull

Material: Aluminium

Item No.	Finish	C-C	L
P17-30C	Polished Chrome	15	30
P17-70C	Polished Chrome	50	70
P17-100C	Polished Chrome	64	100
P17-200C	Polished Chrome	160	200
P17-300C	Polished Chrome	256	300
P17-400C	Polished Chrome	384	400
P17-500C	Polished Chrome	480	500
P17-30MB	Matt Black	15	30
P17-70MB	Matt Black	50	70
P17-100MB	Matt Black	64	100
P17-200MB	Matt Black	160	200
P17-300MB	Matt Black	256	300
P17-400MB	Matt Black	384	400
P17-500MB	Matt Black	480	500

Finish Polished Chrome Matt Black

*16mm Partical Board Screws Included

(Black partical board screws are available to order separately)

Sign Up

to check prices & order online

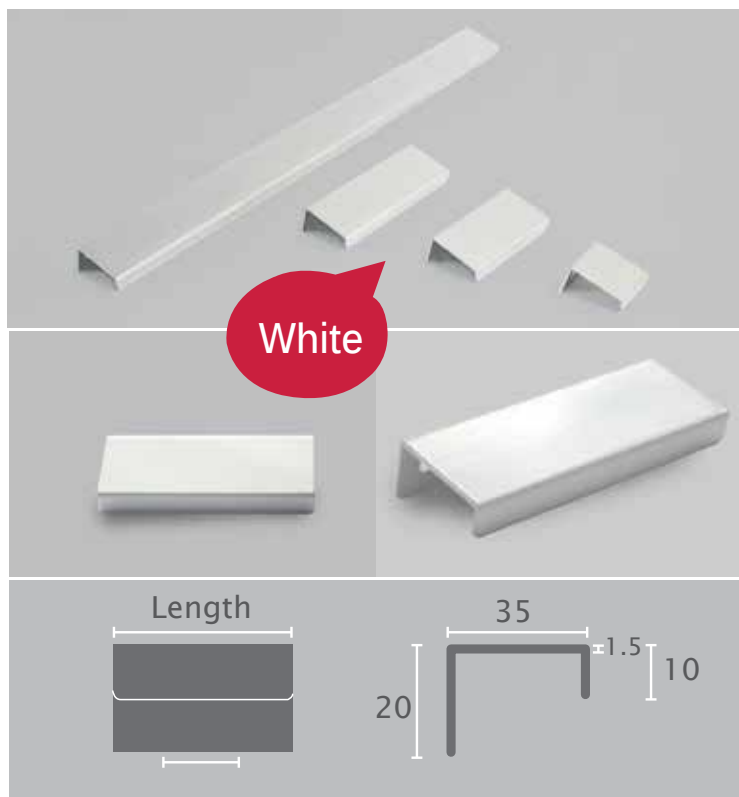

P17 L-Shaped Finger Pull

Material: Aluminium

Item No.	C-C	Length
P17 -30(white)	20	30
P17 -70(white)	32	70
P17-100(white)	80	100
P17-200(white)	160	200
P17-300(white)	220	300
P17-400(white)	384	400
P17-500(white)	420	500



*16mm Partical Board Screws Included



P22 Curled Lip Pull

Material: Aluminium

Item No.	Finish	C-C	L
P22-30	Satin Nickel	15	30
P22-70	Satin Nickel	50	70
P22-100	Satin Nickel	80	100
P22-200	Satin Nickel	160	200
P22-300	Satin Nickel	255	300
P22-30MB	Matt Black	15	30
P22-70MB	Matt Black	50	70
P22-100MB	Matt Black	80	100
P22-200MB	Matt Black	160	200
P22-300MB	Matt Black	255	300
P22-30G	Brushed Brass	15	30
P22-100G	Brushed Brass	80	100
P22-300G	Brushed Brass	255	300



*M4 Screws Included

Sign Up

to check prices & order online

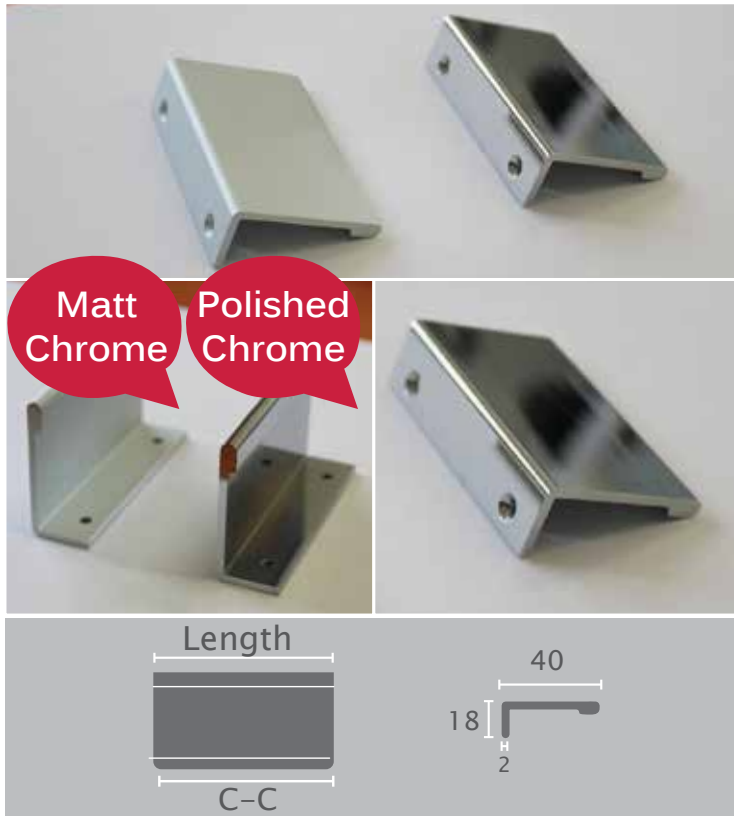

P18 Lip Pull

Material: Aluminium

Item No.	Finish	C-C	Length
P18-70C	Polished Chrome	50	70
P18-70MC	Matt Chrome	50	70

Finish

Polished Chrome

Matt Chrome

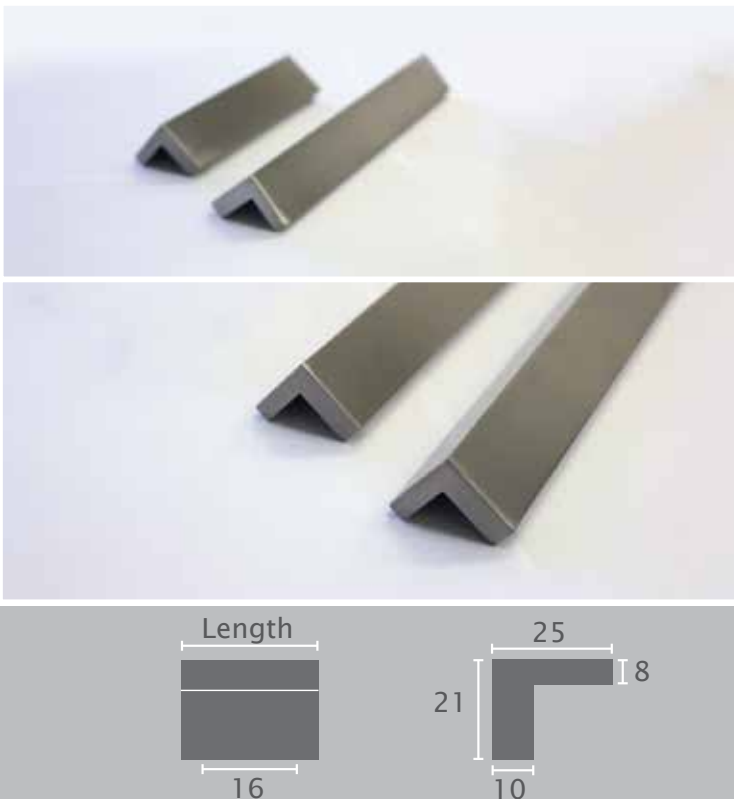

P15 L-Block Finger Pull

Material: Zn-Alloy

Item No.	C-C	Length
P15-96	96	109
P15-128	128	141

Finish

Satin Nickel

*M4 Screws Included

Sign Up to check prices & order online

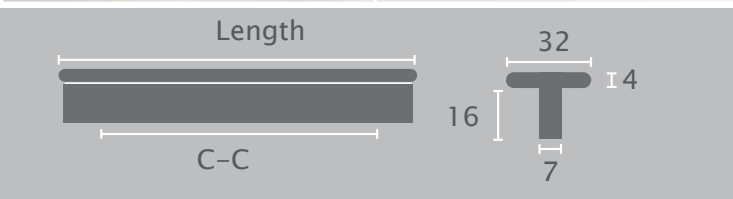

P480 Flat T Handle

Material: Aluminium

Item No.	C-C	Length
P480-96MB	96	121
P480-128MB	128	152
P480-160MB	160	185
P480-224MB	224	249
P480-320MB	320	343
P480-416MB	416	441

Finish **Matt Black**

*M4 Screws Included

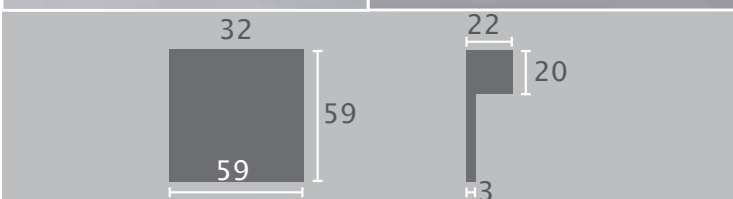
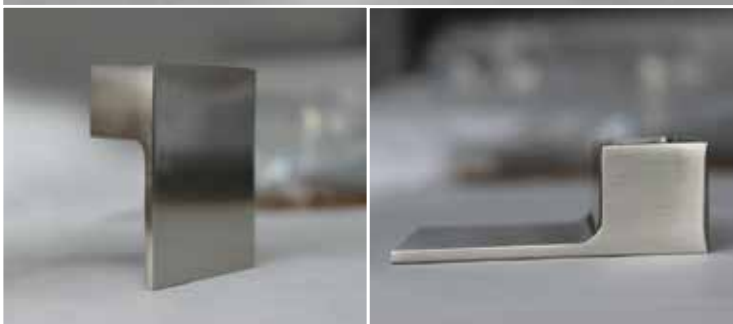

P419 Square Finger Pull

Material: Zn-Alloy

Item No.	C-C	Length
P419	32	59

Finish **Satin Nickel**

*M4 Screws Included

Sign Up to check prices & order online



Sign Up to check prices & order online

www.eurofit.com.au

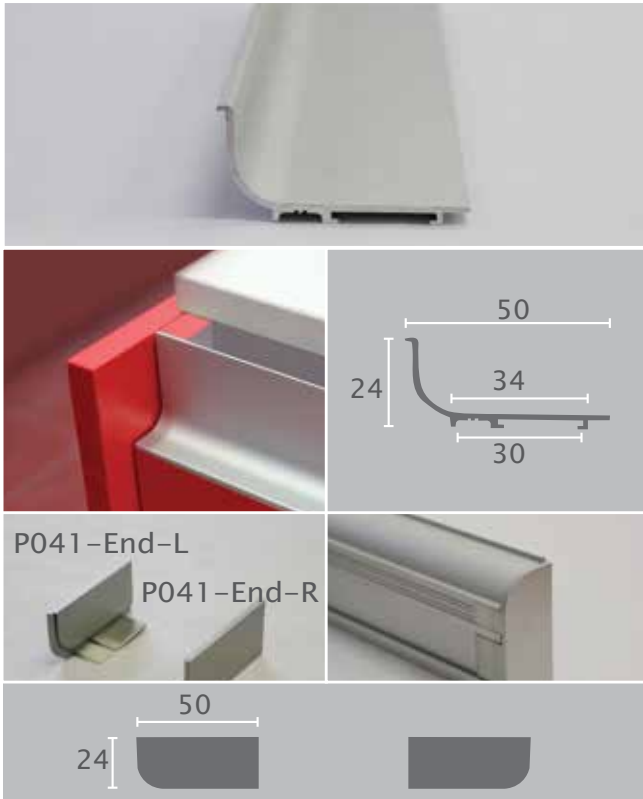

P041 L-Shaped Shadow Line

Material: Aluminium

Item No.	W	Length
P041	50	2.95m

Finish  Matt Chrome

L-Shaped End Cap (L/R)

Material: PVC

Item No.	W	H
P041-End L	50	24
P041-End R	50	24

Finish  Matt Chrome

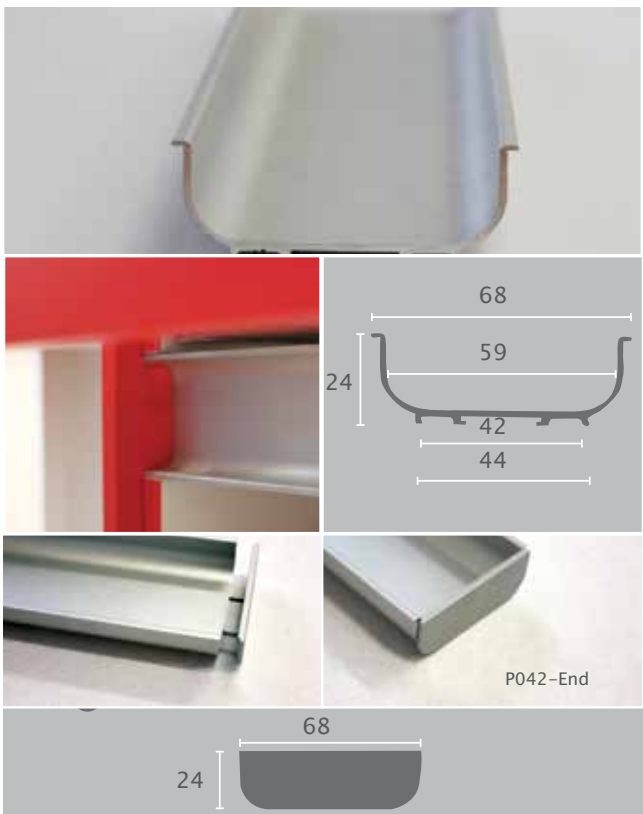

P042 U-Shaped Shadow Line

Material: Aluminium

Item No.	W	Length
P042	68	2.95m

Finish  Matt Chrome

U-Shaped End Cap

Material: PVC

Item No.	W	H
P042-End	68	24

Finish  Matt Chrome

Sign Up

to check prices & order online

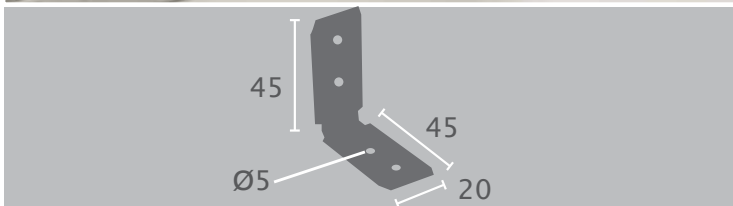

P040 Bracket for P041/P042 Shadow Line

Material: Steel

Item No.	H	W	Length
P040	45	20	45
Finish	 Satin Nickel		

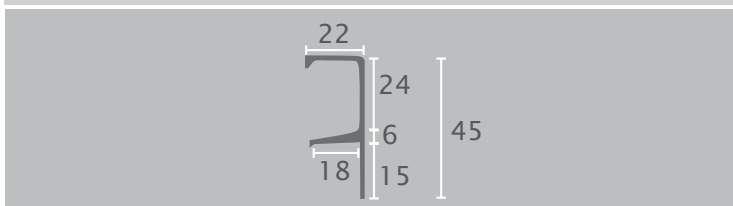

P044 P Section Finger Pull

Material: Aluminium

Item No.	Size	Length
P044	22 x H45	2.95m
Finish	 Matt Chrome	

Sign Up

to check prices & order online



K25 Button Ring Knob

Material: Zn-Alloy

Item No.	H	D
K25	25	31

Finish Satin Nickel

*M4 Screws Included

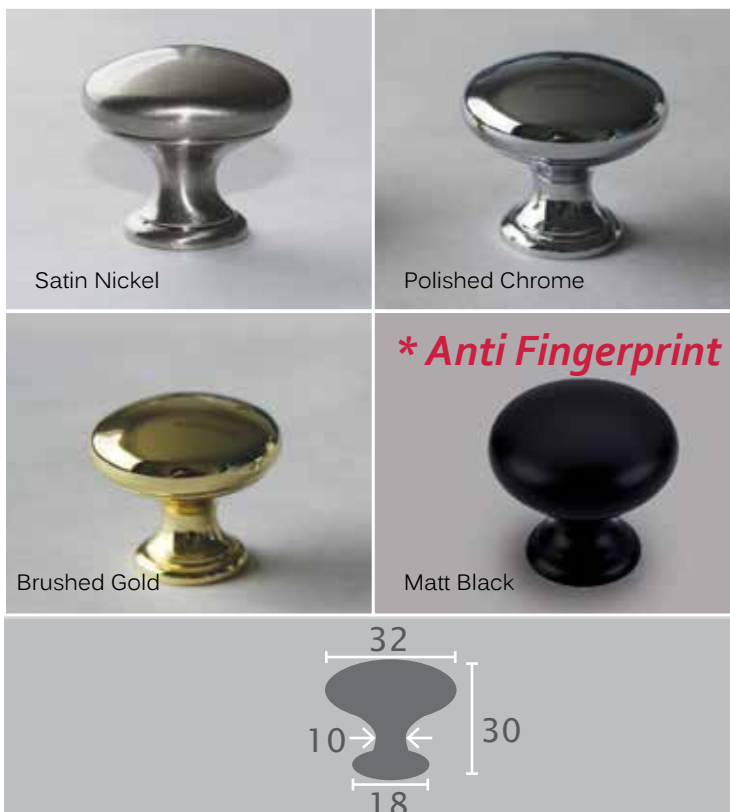

K63 Mushroom Knob

Material: Steel

Item No.	Finish	H	Ø
K63	Satin Nickel	30	32
K63-C	Polished Chrome	30	32
K63-PG	Polished Gold	30	32
K63-MB	Matt Black	30	32

Finish

	Satin Nickel		Matt Black
	Polished Chrome		Polished Gold

*M4 Screws Included

Sign Up to check prices & order online



K56 Football Knob

Material: Zn-Alloy

Item No.	D	Length
K56	18	25
Finish	 Satin Nickel	

*M4 Screws Included

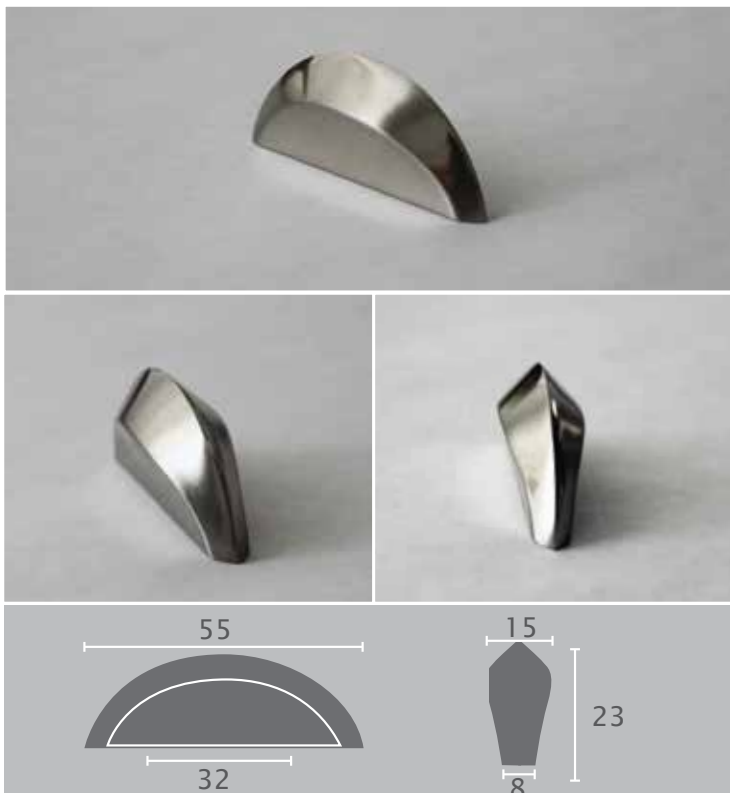

K91 Half Moon Knob

Material: Zn-Alloy

Item No.	C-C	Length
K91	32	55
Finish	 Satin Nickel	

*M4 Screws Included

Sign Up to check prices & order online



K264 Square Pyramid Knob

Material: Zn-Alloy

Item No.	W	Length
K264	32	32
Finish	 Satin Nickel	

*M4 Screws Included



K420 Rectangle Pyramid Knob

Material: Zn-Alloy

Item No.	W	Length
K420	30	48
Finish	 Satin Nickel	

*M4 Screws Included

Sign Up to check prices & order online



K417 Rectangle Knob

Material: Zn-Alloy

Item No.	H	D
K417	25	32
Finish	Satin Nickel	

*M4 Screws Included

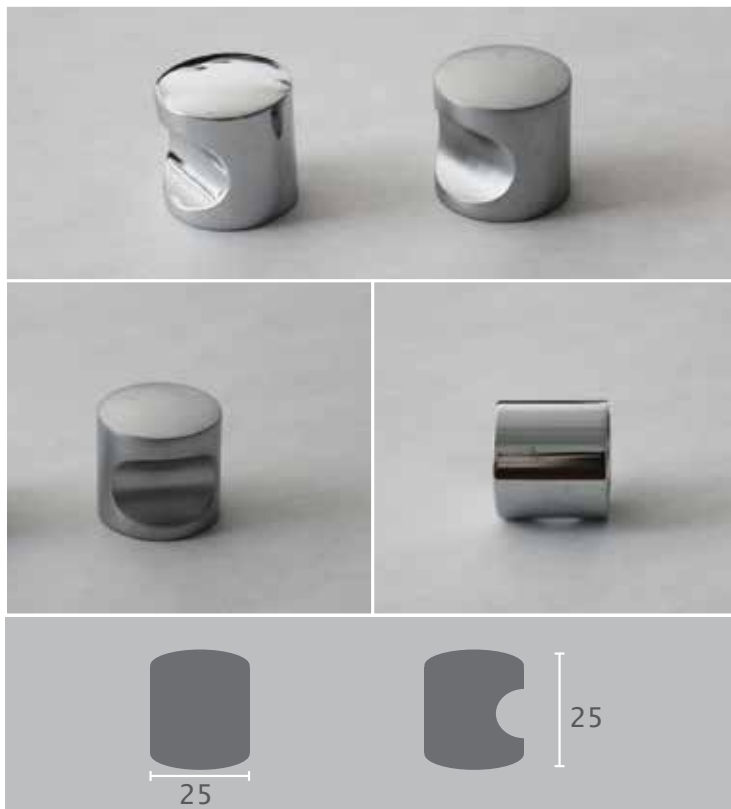

K86 Cylinder Notched Knob

Material: Zn-Alloy

Item No.	Finish	H	Ø
K86C	Polished Chrome	25	25
K86MC	Matt Chrome	25	25
Finish	Polished Chrome	Matt Chrome	

*M4 Screws Included

Sign Up

to check prices & order online



P94s Square Recess Finger Pull

Material: Zn-Alloy

Item No.	Ø	Length
P94S	35	40
Finish	 Satin Nickel	



P196s Round Recess Finger Pull

Material: Zn-Alloy

Item No.	Ø	Length
P196S	35	40
Finish	 Satin Nickel	

Sign Up

to check prices & order online

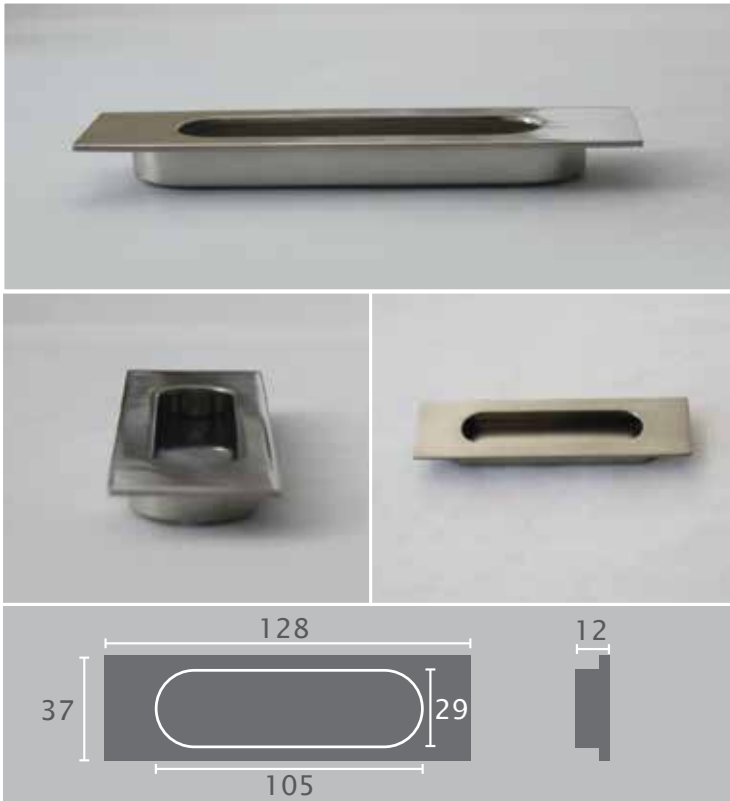

P148 Rectangle Recess Finger Pull



Material: Zn-Alloy

Item No.	W	C-C
P148	37	96
Finish	 Satin Nickel	



P365 Recess Finger Pull

Material: Zn-Alloy

Item No.	C-C	L	H
P365-100MC	100	113	32
P365-100MB	100	113	32
Finish	 Matt Chrome		 Matt Black

*Screws Included

Sign Up

to check prices & order online

Handle Screws (M4) **Phillips Drive**

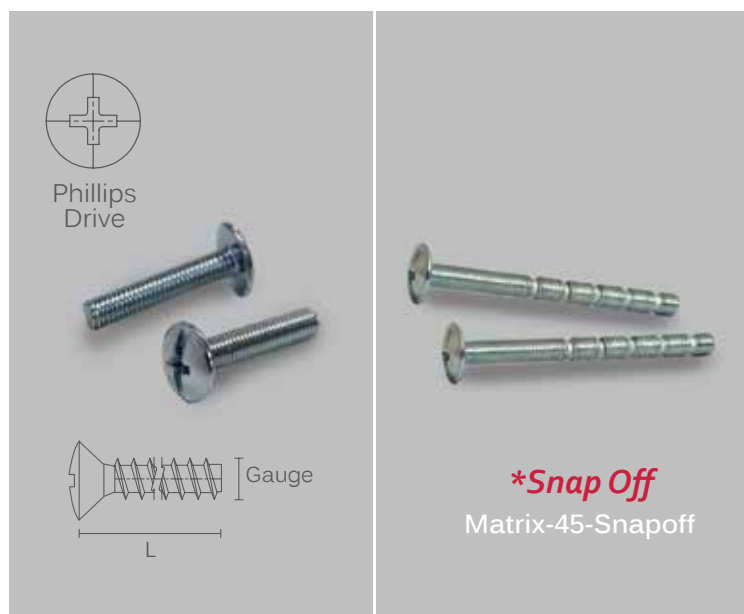

Item No.	L (mm)	Gauge	Carton Qty
Matrix-16	16	4.5mm	1K/Box
Matrix-20	20	4.5mm	1K/Box
Matrix-22	22	4.5mm	1K/Box
Matrix-25	25	4.5mm	1K/Box
Matrix-35	35	4.5mm	1K/Box
Matrix-38	38	4.5mm	1K/Box
Matrix-40	40	4.5mm	1K/Box
Matrix-45	45	4.5mm	1K/Box
Matrix-45-Snapoff	45	4.5mm	1K/Box

• Zinc Plated Finish • Use Phillips #2 • Fine Thread

Hettich

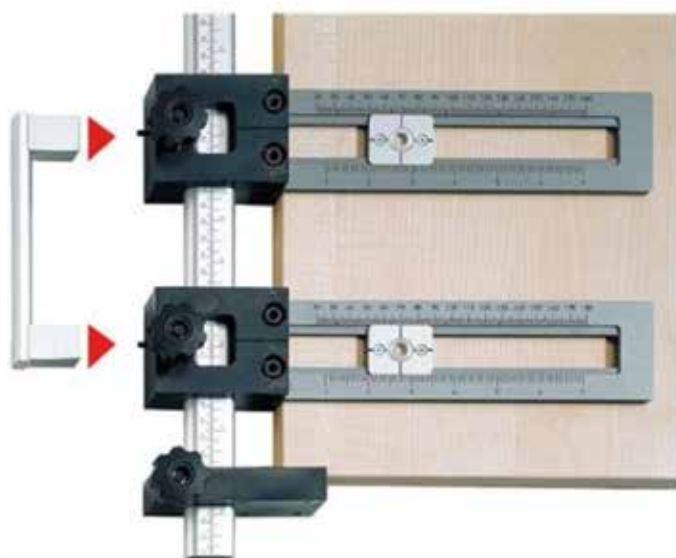

Drilling Jig for Handles

Material: Aluminium, Anodised, Plastic

Item No.	Min. Holes Spacing	Max. Holes Spacing
Hetti-Tool-44763	64mm	500mm

Sign Up

to check prices & order online

Handle Board

Standard



Handle Board

Deluxe



** Please Contact Our Sales Reps For More Details.*

Sign Up

to check prices & order online



H019
Knurled
T-bar
Handle
Page 8



H815
Pipe Handle
Page 47



K179
Antique
Classic Ring
Knob
Page 56



K63
Mushroom
Knob
Page 64



P17
L- Shaped
Finger Pull
Page 57-58



H511
Half Moon
Finger Pull
Page 1-2



H367
Table Handle
Page 36



H299
Half Round
D Handle
11mm
Page 10

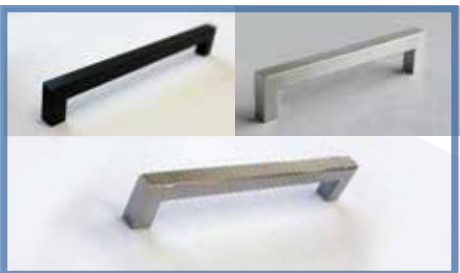

H501
All Square
Block
Handle
Page 15-16

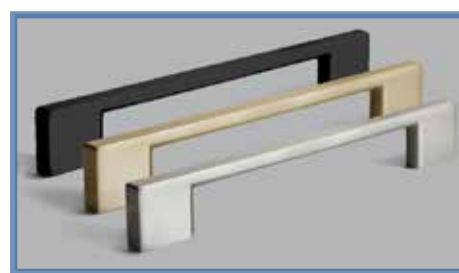

H904
Slim Profile
Handle
Page 29